

Art that  
**FIGHTS**  
fire

*Technical Data Sheet*  
*SD - EI<sub>2</sub> 120*

**meverin**<sup>®</sup>  
F I R E D O O R S

# EN FF € EI<sub>2</sub> 120 SLIDING DOOR 1-2 LEAVES

*with or without WICKET DOOR*



## TECHNICAL FEATURES

### Top-hung running track

**NEW:** multifunctional structural horizontal top-hung running track (patented), made in continuous mode in high-strength steel profile, shiny zinc-plated, with built-in rack.

The top-hung running track, made to measure, is prepared and pre-drilled for fastening to the support element by means of dowels (dowels not included).

Where the dimensions require a segmentation of the running track, it is supplied with push-fit joints.

Front cover of the running track through a RAL 7035 pre-painted sheet metal casing included for sliding doors with HN (Net Height) up to 2700 mm (over 2700 optional and on request).

Floor guide (consisting in a combination/set of bearings) positioned on the floor beyond the wall aperture, always supplied.

Linear floor guide included, over LN (Net wall aperture) 4900 mm.

### Hanging system - CARRIER

**NEW:** FIRE AND SMOKE BARRIER suspension and overhead sliding system (patented) consisting of a continuous steel profile element with vectorial load with integral, balanced, flex-oscillating and millimeter-accuracy carriers for uniform load distribution.

For each modular panel there are carriers equipped with double running track.

### Leaf

Made with cut-to-measure modular panels assembled through coplanar male/female push-fit joints (patented) and fixed on both sides by visible screws (the screws are included in the supply).

**NEW:** upper reinforcing structure for the leaf connected to the carrier and lower reinforcing structure in profiled metal sheet.

Suitably shaped coating metal sheet on the two external faces with programmed deformability.

**NEW:** MEV FIRUX<sup>®</sup> (patented) continuous internal insulating pack, resistant to high temperatures, available even in large dimensions.

**Dynamic overlapping and overall dimensions** depending on the size of the sliding door, in compliance with the standard.

Guided and facilitated assembly sequence thanks to the complete preparation of all the details (thoroughly vetted at the factory) and the numerical progression shown on the panels and on the lower reinforcing structure with the absolute advantage of a successful installation and reduced installation times.

### Handles

Recessed on both sides of each leaf, positioned so as to retract according to dynamic overlapping.

### Smoke labyrinth seals

In press-folded and pre-drilled sheet steel for fixing by means of pre-set screws. The wall side labyrinth seals are completed with an insulating sheet and finished with FIRUX<sup>®</sup> intumescent fire seals.

### FIRUX<sup>®</sup> type intumescent fire seal

Placed on all labyrinth seals and between panels.

### Accident prevention systems

**NEW:** hydraulic device (patented) for speed control VTK (Viscotroller<sup>®</sup> Kallipè<sup>®</sup>) – at a slow and short pace – which acts in synergy with the top-hung running track by coupling with the rack, therefore guaranteeing full safety when closing the door leaf with a soft and delicate closure. Life-saving device

**NEW:** SAM K, soft close damper, cushions and accompanies the door during the final stage of closing.

### Operation (door hold-open retainer)

Standard with electromagnet as per DoP declaration.

### Counterbalance weights

Closure with counterbalance weight protected by a RAL 7035 pre-painted sheet metal casing in the various versions.

- Front
- Offset front
- Opposite side
- Opposite side offset
- **NEW:** fixed on the leaf, INTEGRAL WITH THE LEAF

### Wicket door (optional)

	Door size			Wicket door aperture dimensions	
	LN (1 leaf)	LN (2 leaves)	HN	LNp	HNp
Wicket door with sill (92 mm)	1580	3500	2250	850	2090
	1870	4000	2250	1140	2090
Wicket door without sill	1580	3500	2200	850	2000
	1870	4000	2200	1140	2000

The measurements are expressed in mm.

For lower LN (Net wall aperture) ask for feasibility.

In the case of a HN (Net Height) lower than the measures listed above, the height of the wicket door (HNp) is to be reduced.

### Applications

- Surface mounted on solid and load-bearing masonry or reinforced concrete wall
- Lintel mounted or mounted on an insulated structure finished with plasterboard.

### Finish

The sliding doors are made of galvanized sheet metal and finished with an ecological primer paint, of industrial type, with high quality epoxy resins, which guarantee protection against corrosion from a vast range of aggressive agents, acid and non-acid, in environments not directly exposed to the outdoor natural atmosphere. Standard color RAL 7035. A wide range of RAL and NCS is available on order.

**NEW:** execution in AISI 304 or 316 stainless steel (excluding running track, point floor guide and accessories)

### Identification plate

Applied on the shell handle with the appropriate CE mark and with personalized polychrome CARD with identification data.

### Documentation provided (CE marking)

Composed by:

- DoP declaration of performance
- declaration of conformity with machinery directive
- installation, use and maintenance manual
- installation instructions

### EI<sub>2</sub> 120 LEAF weight and thickness

- Average nominal weight 51 kg/m<sup>2</sup>
- **NEW:** nominal thickness 120 mm

### EI<sub>2</sub> 120 field of application with CE marking

	Sliding Door 1 leaf EI <sub>2</sub> 120		Sliding Door 2 leaves EI <sub>2</sub> 120	
	LN	HN	LN	HN
Maximum dimensions	10000 mm	8225 mm	5600 mm	5027 mm
Maximum surface	50 mq		50 mq	
Decreasing dimensions	UNLIMITED		UNLIMITED	

**COUNTERBALANCE WEIGHT - FRONT VERSION - CE MARKED - COMPLYING WITH EN 16034 - EN 13241**

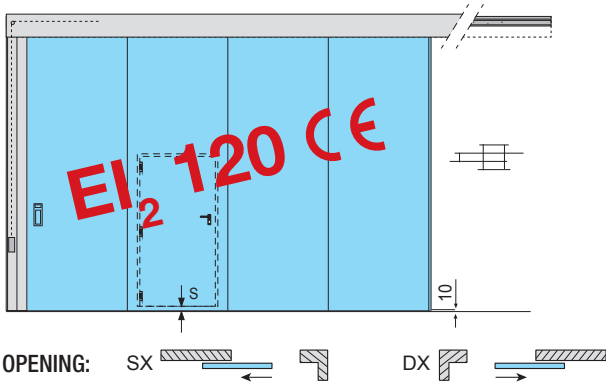

**FRONT (STANDARD) COUNTERBALANCE WEIGHT**

On request, angled counterbalance weight to contain the overall dimensions up to 40 mm. ③

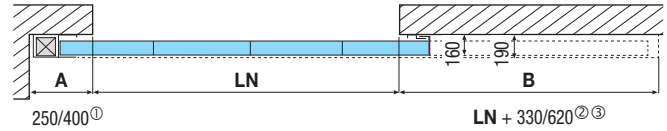

LN	overall dimensions door-stop A ①	overall dimensions opening B ②
up to 2700 mm	250 mm	LN + 330 mm
2701 to 4900 mm	280 mm	LN + 380 mm
4901 to 8000 mm	400 mm	LN + 620 mm

**CONCRETE BEAM**

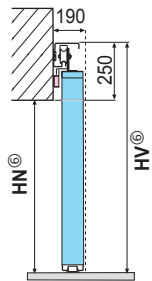

**BEAM WITHIN HEIGHT**

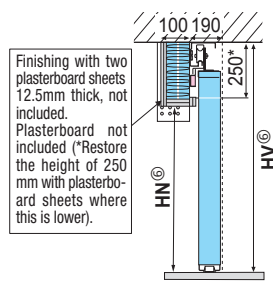

**OFF AXIS COUNTERBALANCE WEIGHT**

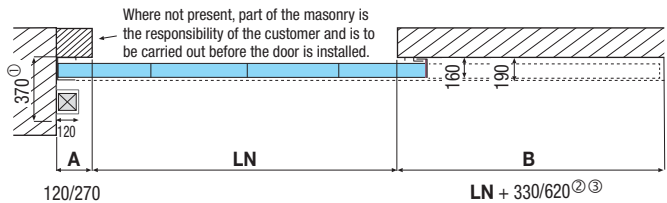

LN	overall dimensions door-stop A	overall dimensions opening B ②
up to 2700 mm	120 mm	LN + 330 mm
2701 to 4900 mm	150 mm	LN + 380 mm
4901 to 8000 mm	270 mm	LN + 620 mm

**COUNTERBALANCE WEIGHT- OPPOSITE SIDE VERSION - CE MARKED - COMPLYING WITH EN 16034 - EN 13241**

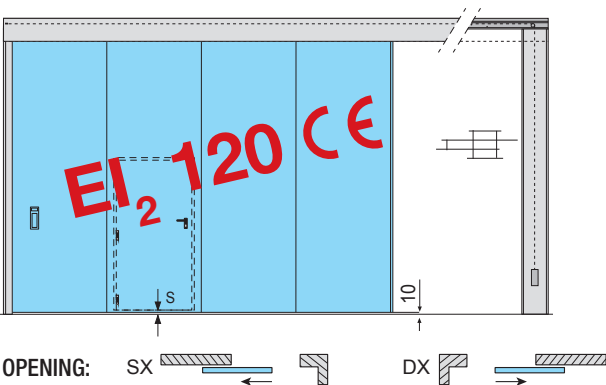

**OPPOSITE SIDE COUNTERBALANCE WEIGHT**

On request, angled counterbalance weight to contain the overall dimensions up to 40 mm. ③

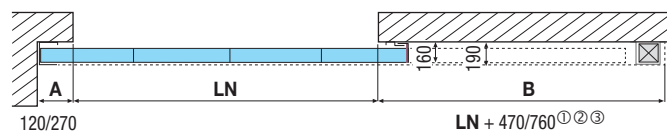

LN	overall dimensions door-stop A	overall dimensions opening B ①②
up to 2700 mm	120 mm	LN + 470 mm
2701 to 4900 mm	150 mm	LN + 520 mm
4901 to 8000 mm	270 mm	LN + 760 mm

**CONCRETE BEAM**

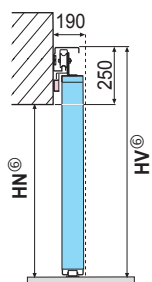

**BEAM WITHIN HEIGHT**

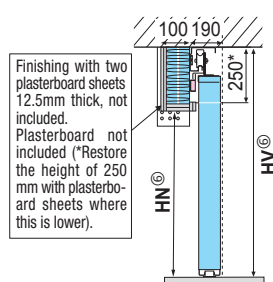

**OPPOSITE SIDE OFF AXIS COUNTERBALANCE WEIGHT**

(It is advisable to opt for the solution with together counterbalance weight)

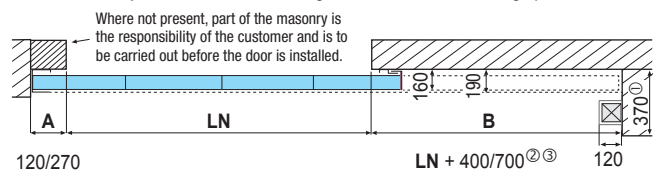

LN	overall dimensions door-stop A	overall dimensions opening B ②
up to 2700 mm	120 mm	LN + 400 mm
2701 to 4900 mm	150 mm	LN + 460 mm
4901 to 8000 mm	270 mm	LN + 700 mm

**COUNTERBALANCE WEIGHT - TOGETHER VERSION - CE MARKED - COMPLYING WITH EN 16034 - EN 13241**

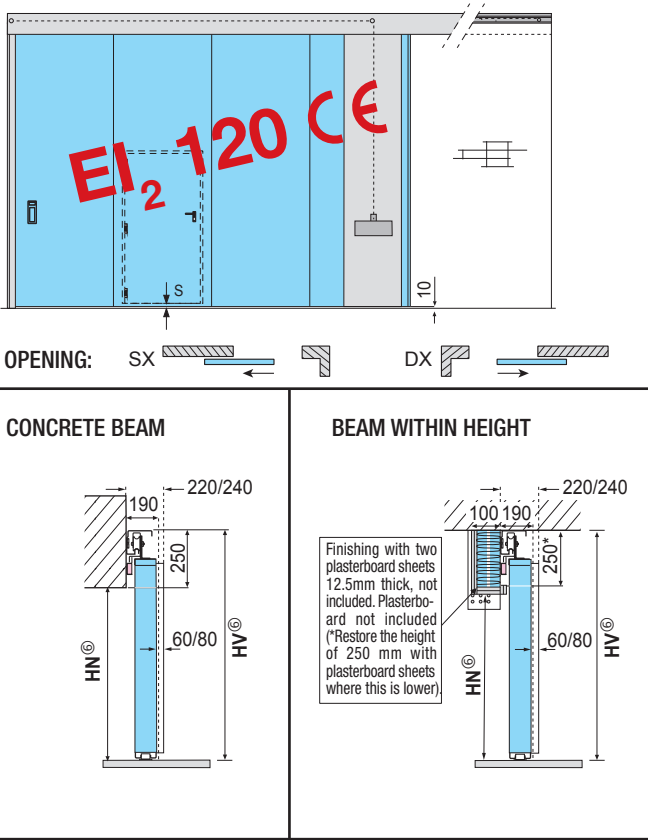

**APPLICAZIONE CONTRAPPESO SOLIDALE ANTA<sup>57</sup>**

The position of the counterweights together with the leaf, due to production requirements, may not be at the end of the door.

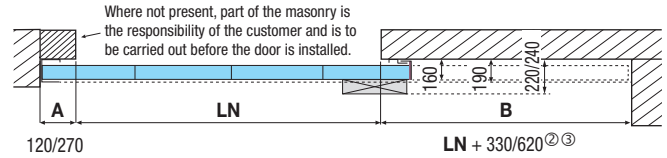

LN	overall dimensions door-stop A	overall dimensions opening B <sup>2</sup>
up to 2700 mm	120 mm	LN + 330 mm
2701 to 4900 mm	150 mm	LN + 380 mm
4901 to 8000 mm	270 mm	LN + 620 mm

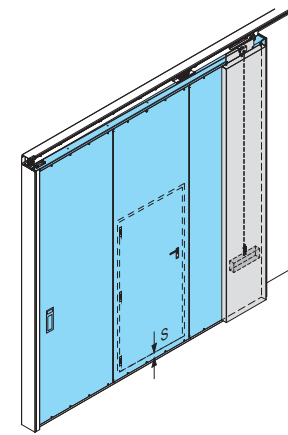

**COUNTERBALANCE WEIGHT - ORDINARY VERSION 2 LEAVES - CE MARKED - COMPLYING WITH EN 16034 - EN 13241**

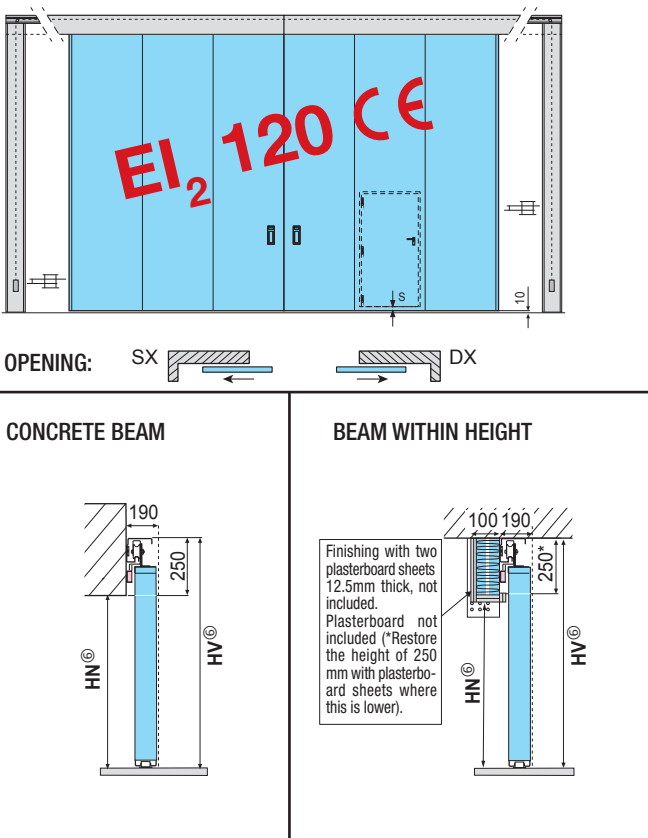

**BASE (STANDARD) COUNTERBALANCE WEIGHT**

On request, angled counterbalance weight to limit the overall dimensions up to 40 mm per side.<sup>9</sup>

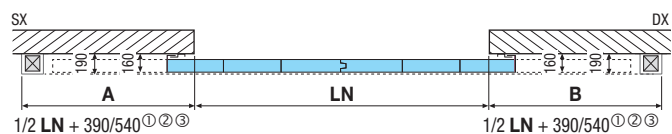

LN	overall dimensions opening A/B <sup>1 2</sup>
up to 2700 mm	1/2 LN + 390 mm
2701 to 4900 mm	1/2 LN + 420 mm
4901 to 5600 mm	1/2 LN + 540 mm

**OFF AXIS COUNTERBALANCE WEIGHT**

(It is advisable to opt for the solution with together counterbalance weight)

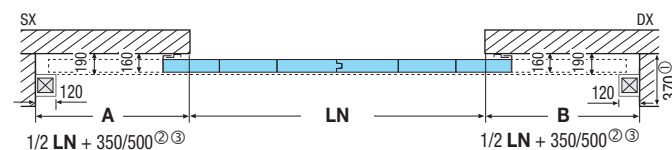

LN	overall dimensions opening A/B <sup>2</sup>
up to 2700 mm	1/2 LN + 350 mm
2701 to 4900 mm	1/2 LN + 380 mm
4901 to 5600 mm	1/2 LN + 500 mm

COUNTERBALANCE WEIGHT - TOGETHER VERSION 2 LEAVES - CE MARKED - COMPLYING WITH EN 16034 - EN 13241

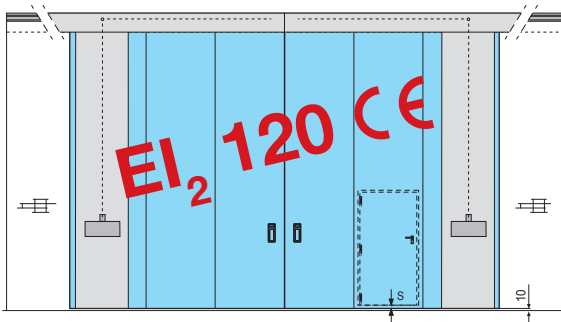

OPENING: SX DX

CONCRETE BEAM

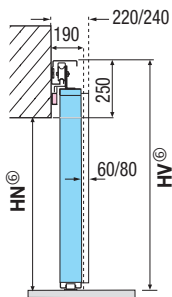

BEAM WITHIN HEIGHT

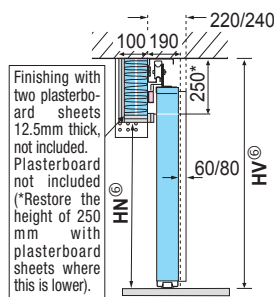

TOGETHER WITH LEAF COUNTERBALANCE WEIGHT APPLICATION<sup>®</sup>

The position of the counterweights together with the leaf, due to production requirements, may not be at the end of the door.

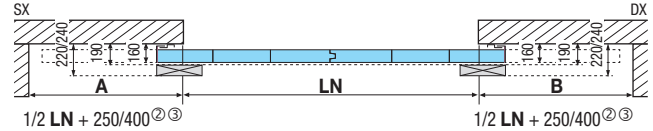

LN	overall dimensions opening A/B <sup>®</sup>
up to 2700 mm	1/2 LN + 250 mm
2701 to 4900 mm	1/2 LN + 280 mm
4901 to 5600 mm	1/2 LN + 400 mm

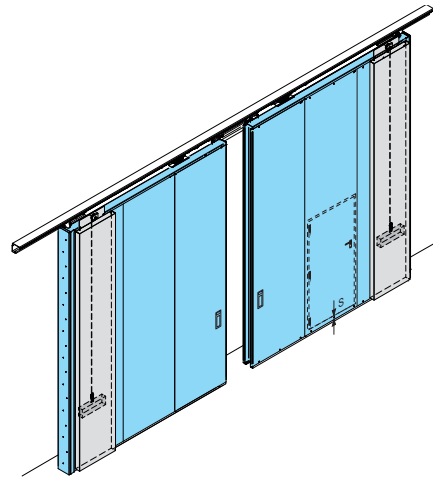

SOLUTION WITH AND WITHOUT RUNNER TRACK CASING

WITHOUT RUNNER TRACK CASING

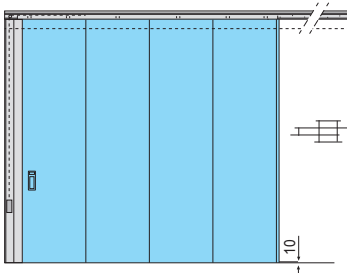

WITH RUNNER TRACK CASING

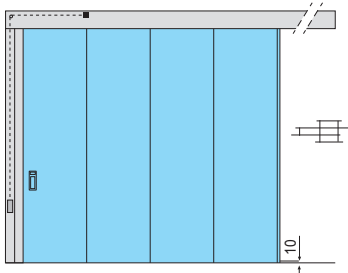
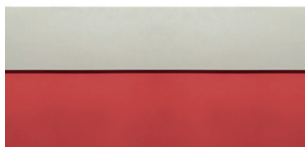

LEAF finish is RAL 7035, or RAL of your choice upon payment. The finish of the COUNTERBALANCE WEIGHT CASING is also RAL 7035 (when the finish of the sliding door is RAL 7035) or the same RAL finish as the door (when the sliding door RAL finish of your choice is different).

The supplied FIXED PROFILE is zinc-plated. The finish of the RUNNER TRACK CASING (optional over 2700 mm Nominal Height) is RAL 7035 (when the finish of the sliding door is RAL 7035) or the same RAL finish as the door (when the sliding door RAL finish of your choice is different).

INSTALLATION OPTIONS:

- MOUNTED ON MASONRY AND REINFORCED CONCRETE
- LINTEL MOUNTED, RECESSED Fig 1
- MOUNTED ON LOAD-BEARING METAL STRUCTURE Fig 2

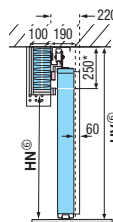

Lintel mounted, recessed in wall aperture 100x250 mm. Plasterboard sheets 12.5mm thick, not included. Plasterboard not included. (\*Restore the 250 mm elevation with plasterboard sheets if needed) Rockwool 150 kg/mc. Side fixing plates.

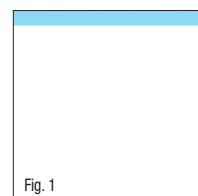

Recessed lintel in insulated steel tube 100x250 mm, for EI<sub>2</sub> 120 sliding doors with one and two leaves. The lintel finishing with 12.5 mm plasterboard sheets is not included.

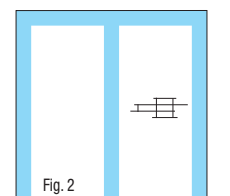

Example of load-bearing structure made in insulated steel tube 100x250 mm, for EI<sub>2</sub> 120 sliding doors with one and two leaves. The lintel finishing with 12.5 mm plasterboard sheets is not included.

EN FF CE EI<sub>2</sub> 120 SLIDING DOOR 1-2 LEAVES

**WICKET DOOR (optional)**

The hinged wicket door fitted in the leaf of a horizontally sliding door does not fall within the scope of the UNI EN 14351-1 standard, even if equipped, at the request of the Client, with an easy opening device, even if CE marked according to UNI EN 179 or UNI EN 1125. The end user remains solely responsible for the appropriate use of such door.

The wicket door is usually fitted in the 1st module of the sliding doorset after the module housing the handle, unless specifically requested otherwise. The handing of the wicket door must be chosen according to the handing of the sliding doorset.

STANDARD DOORSILL S= 92 mm  
WITHOUT DOORSILL<sup>®</sup> S= 0 mm  
LNp 850 mm o 1140 mm  
HNp 2090 (HN min 2250 per S=92 mm e HN min 2200 per S=0)

**RECOMMENDED OPENINGS**

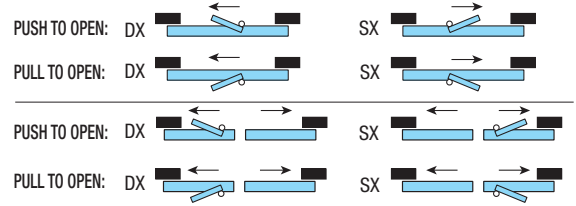

**PULL-TO-OPEN WICKET DOOR with handle**

(opening of the wicket door towards the side opposite the wall)

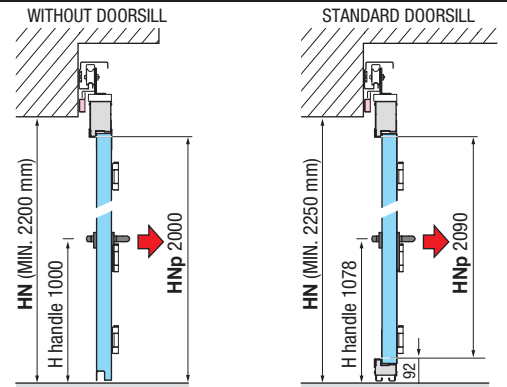
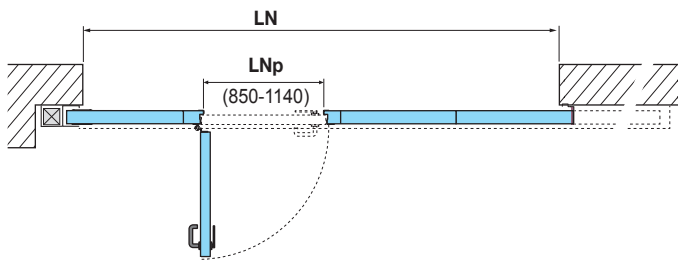

**PULL-TO-OPEN WICKET DOOR with easy opening device**

(opening of the wicket door towards the side opposite the wall)  
Horizontal and vertical shimming is required.

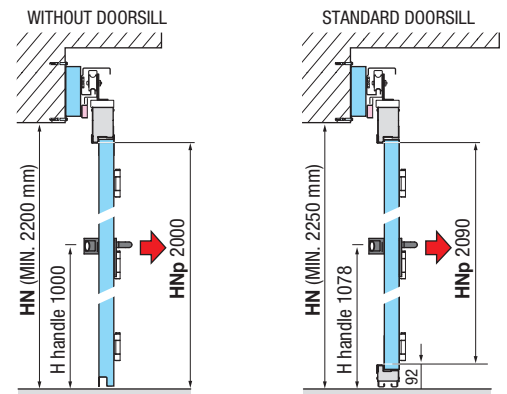
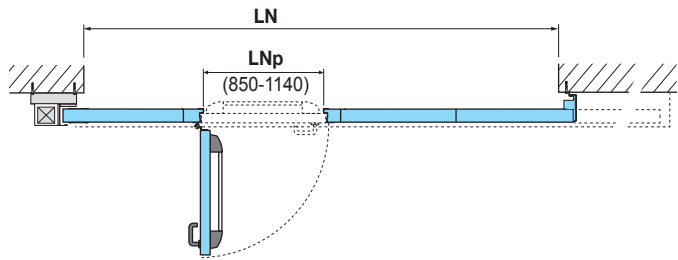

**PUSH-TO-OPEN WICKET DOOR with or without easy opening device**

(opening of the wicket door towards the wall side)  
Horizontal and vertical shimming is required.

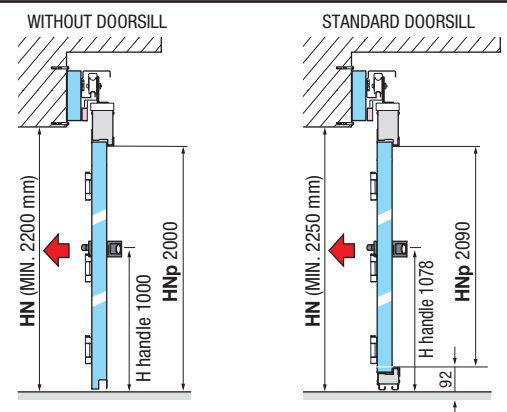
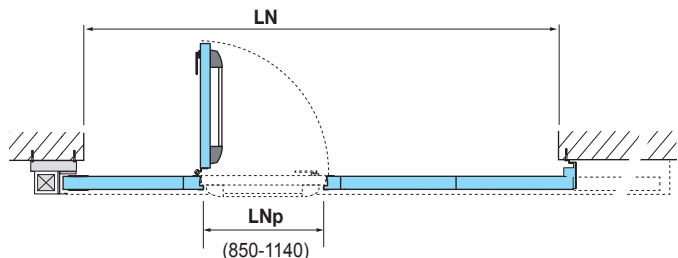

**NOTE**

- Low traffic flow fire compartmentation element not to be used improperly.
- Install in environments not subject to air drafts.
- Assembly to be carried out only by specialized personnel.
- Install only on perfectly square and level compartments or structures.
- For special cases indicate the spaces available and apply to our technical department.
- Precaution in use and risk analysis are the responsibility of the customer.
- Detection system, preferably centralized, to be provided by and at the expense of the customer.
- The panels, due to production requirements, may be unequal.

- ① For the actual overall dimensions, check sizes and / or apply to the technical department. In the case of sizes R and SP, overall dimensions are to be increased by minimum 105 mm.
- ② At door end overall dimensions are to be increased by 140 mm in case of CC 2800N electromagnet.
- ③ Minimum dimensions: indicate the available clearance, opening side, if it is around the minimum indicated.
- ④ For HN (net height) > 7150 the upper and lower reinforcing structure may have a different size from the usual one and the handle can be positioned higher.
- ⑤ Feasibility check for LN (net wall aperture) > 6000.
- ⑥ HN / HV is to be measured from finished floor elevation.
- ⑦ Solution possible for direct COUNTERBALANCE WEIGHT and one idler (sizes to be verified) and for LN (net wall aperture) 6000.
- ⑧ Solution possible only for symmetrical leaves with LN (net wall aperture) 8000 and for COUNTERBALANCE WEIGHT and one idler (sizes to be verified).
- ⑨ Apply to our technical department to check for feasibility.

- Drawings are provided by way of example therefore they are out of scale.
- The dimensions are expressed in millimeters.
- The protocol / file number will be attributed upon order or production confirmation.
- Meverin reserves the right to make any changes it deems appropriate to this document at any time and without notice.



## ACCESSORIES

### END OF TRAVEL DAMPER SAM K (Shock Absorber Magnetic)

**TECHNICAL FEATURES:**

The compression energy on the stem is absorbed by compressing the hydraulic fluid through an adjustable relief valve. The damper stem, once compressed, is automatically rearmed for a new cycle.

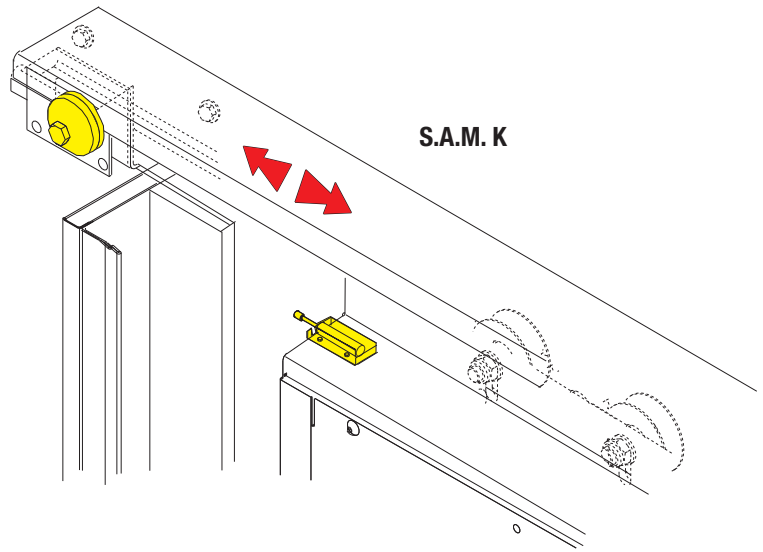

### VTK - VISCOTROLLER® KALIPÉ® DOOR TRAVEL DAMPER

NB:  
 Do not force the seal in order to avoid oil leaks.

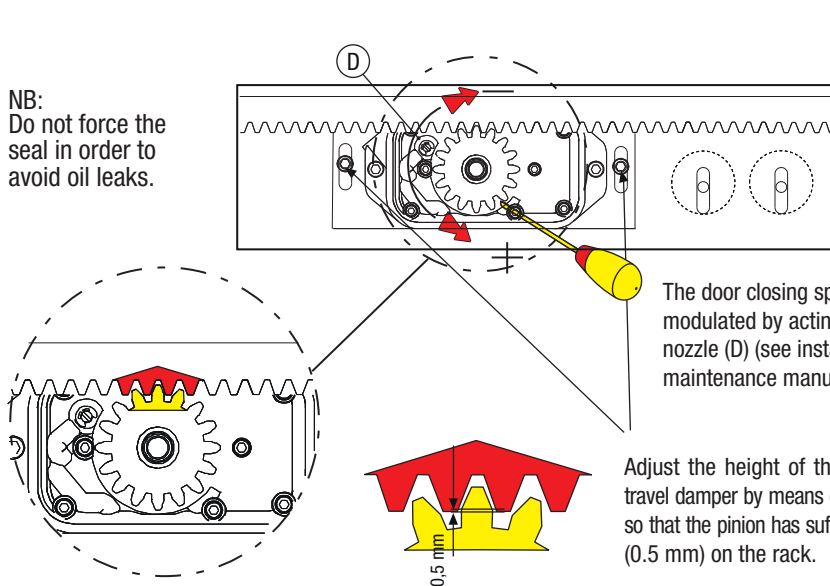

NB:  
 The drive direction can be reversed by rotating the ROTOR (C) by 180°.

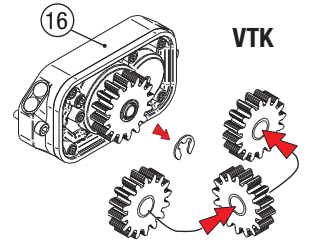

The door closing speed must be modulated by acting directly on the nozzle (D) (see installation, use and maintenance manual).

Adjust the height of the VTK door travel damper by means of the slots so that the pinion has sufficient play (0.5 mm) on the rack.

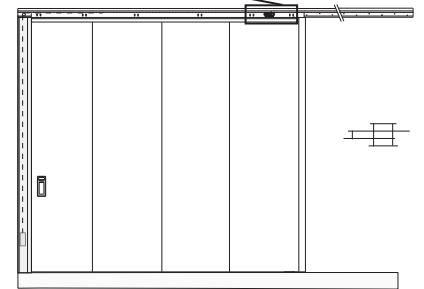

### ELECTROMAGNET - ELM K

Model CC 1400N

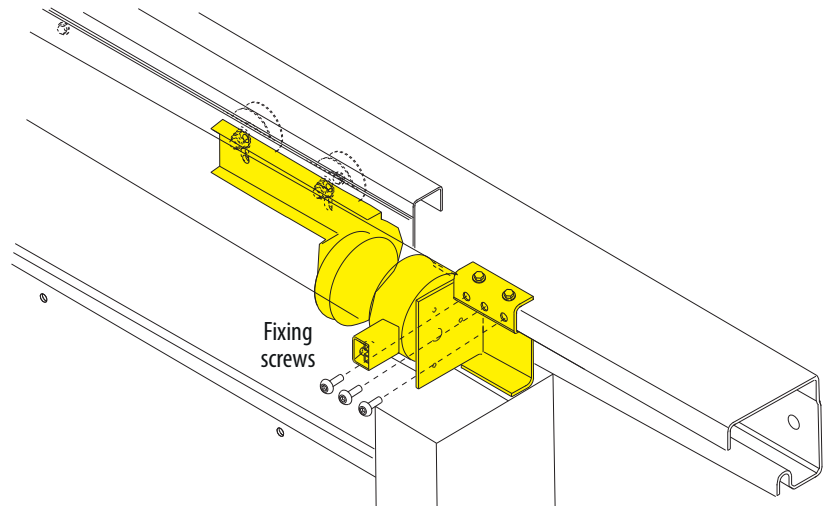

## ACCESSORIES

### FLOOR GUIDE RAL 3000 (provided for LN -net wall aperture- 4900 mm)

After adjusting the door, position **the floor guide** where required (length of the LN – net wall aperture) in the opening and screw it to the floor using the pre-drilled holes. In the case of a wicket door without sill, the conformation of the floor guide is different.

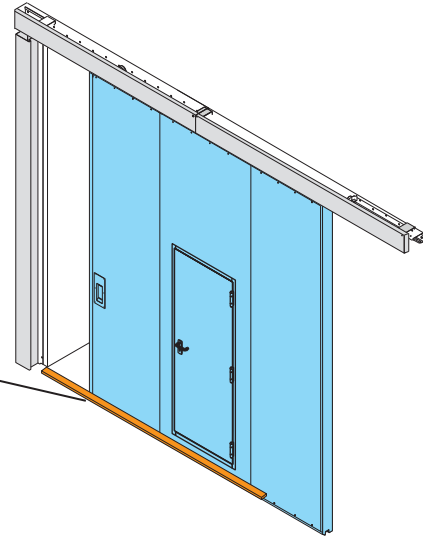
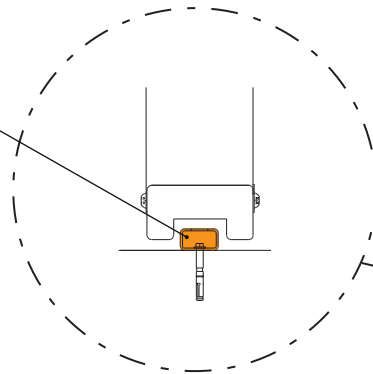

### EXTERNAL NIGHT LOCK

Can only be opened on one side.

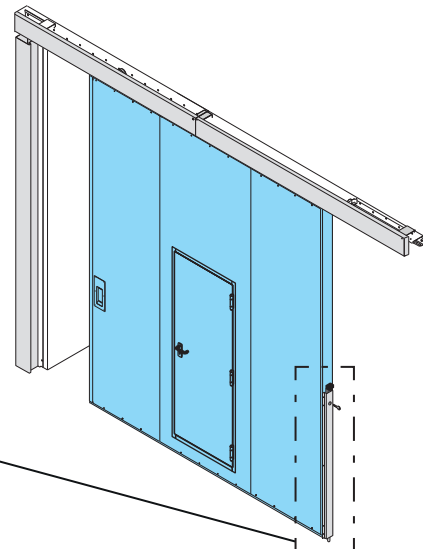
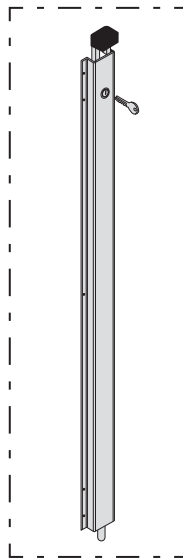

### INTERNAL NIGHT LOCK

To be foreseen when placing the order.

Can be opened on both sides.

Feasibility check for 1 leaf with LN (net wall aperture) <700 mm.

Feasibility check for 2 symmetrical leaves with LN (net wall aperture) <1600 mm.

