



# Kapılar & pencereler

Çelik ve paslanmaz çelikten yapılmış  
yalıtımsız profil sistemleri

**JANSEN**

# Yalıtımsız kapı ve pencereler. Yalıtımsız ancak tam fonksiyonel.

Kapı ve pencereler insanlar için ferahlığı sembolize eder, ışık ve hava için giriş temin eder. Aynı zamanda da dış etkenlerden koruma sağlar. Isı yalıtımı, ses yalıtımı, hırsızlığa karşı koruma veya kurşun geçirimsizlik gibi özel gereksinimler kapı ve pencerelerin nasıl imal edileceğini belirler.

Çelik ve paslanmaz çelikten kapı ve pencere için imal edilen Jansen'in yalıtımsız profil sistemleri, binanın yalıtım özelliği aranmayan, gerekli ısı yalıtım beklentilerinin karşılandığı kısımlarında kullanım için uygundur.

Jansen Economy serisi kapı ve pencere sistemleri, EPDM fitil ve polietilen bazlı yapışkan bant camlama için uygundur, ekonomiktir ve kullanım esnekliği sağlar. Minimum temel derinlikleri sayesinde, dar imalatlarda bile hem yüz olarak uygulanabilir ve maksimum dayanımı garantilerler. Kapı sistemlerinde aynı zamanda kolay geçiş sağlayan eşik uygulaması mevcuttur.

Ürün gamı aşağıdaki profil serilerinden oluşur:

- Jansen-Economy 50 kapıları (çelik ve paslanmaz çelik): 50 mm profil derinliği ile tek ve çift kanatlı kapı ve sabit doğramaların hem yüz uygulaması için uygundur.
- Jansen-Economy 60 kapıları (çelik): 60 mm profil derinliği ile geniş, tek ve çift kanatlı kapıların ve sabit doğramaların hem yüz uygulaması için uygundur.
- Jansen-Economy 50 pencereleri (çelik ve paslanmaz çelik): 50 mm profil derinliği ile tek açılım, çift kanat açılım ve vasistas açılım için uygundur.

Jansen Economy sistemleri, EN 14351-1 ürün standardında belirlenen testleri başarı ile geçmiştir.

**Buna dayanarak, üreticiler pencere ve harici kapılara, AB'nin mecburi tuttuğu CE markalamasını yapabilirler.**



# Jansen-Economy Kapı ve Pencereleeri



## Her beklenti için zarif çözümler

Bu profil serisi, sade profil geometrisi, ince yapısı ve maksimum dayanıklılık özelliklerine sahiptir. Bu düzgün ve ekonomik bir kurulum imkânı demektir. Tek ve çift kanatlı kapılar, hareketli veya sabit üst ve yan ışıklıkları ile Jansen-Economy 50 ve 60 serileri tüm bina gereksinimlerini karşılayacak yaratıcı çözümler sunar.

Jansen-Economy 50 ve 60 kapı imalatları, etkileyici hem yüz tasarımına sahiptir, içeride ve dışarıda sürekli gizli oluklar ve çift kanal contaları mevcuttur. Kapı eşiğine gerektiği durumlarda otomatik eşik kapatıcı veya kapı altı contası uygulanabilir.



## Jansen-Economy 60 parmak koruyucu kapılar: Güvenlik ve tasarımın mükemmel birleşimi

Yuvarlatılmış yarı profiller yan kapanma köşelerinde yarananma riskini en aza indirirler. Bu tasarım DIN 18650 normunda belirtildiği gibi ezilme ve kesme noktalarını engeller. Bakım gerektirmeyen yüksek performanslı menteşeleri ile Jansen-Economy 60 parmak koruyucu kapıları, özellikle insan

trafiğinin yoğun olduğu alışveriş merkezi, okul ve hastane gibi binalar için uygundur. Jansen-Economy parmak koruyucu kapılar EN 14351-1 standardını dış kapılar için karşılar ve CE sertifikasına sahiptir. Parmak koruyucu kapılar Janisol profil gamı ile uyumludur. Entegre kapı kapatıcılar, otomatik yana monte hareket mekanizmaları ile uyumlu çalışır.



## Jansen-Economy pencereleri – ince görüntüsü ile güncele uygun

50 mm kanat profil derinliği ile (veya 58.5 mm) Jansen-Economy 50 tek açılım, çift açılım, çift kanat tek açılım veya vasistas açılım pencere kanatları için de uygundur. Test edilmiş, sisteme özel aksesuarlar her pencere açılımı

için mevcuttur ve alüminyum veya paslanmaz çelik pencere kolları ile tamamlanmaktadır. Jansen-Economy 50 pencere sisteminin yalıtımı iç ve dış camla fitilleri ile sağlanmaktadır.



Jansen Economy 50 kapı örnekleri

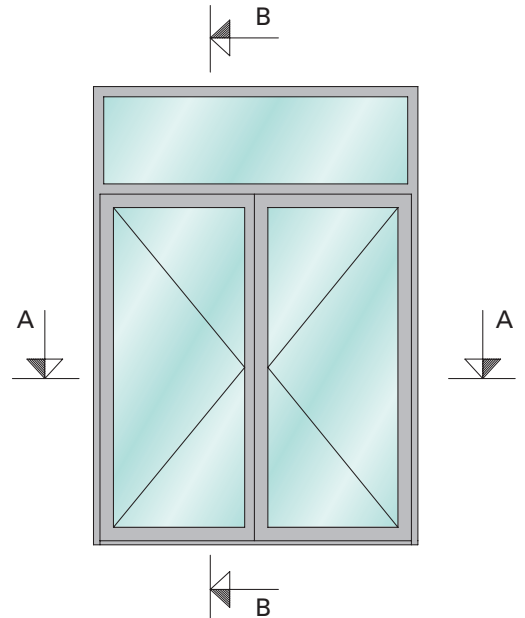
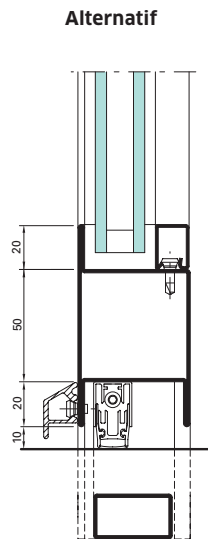
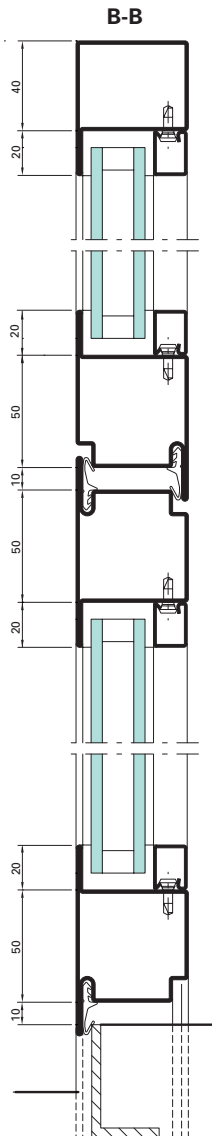
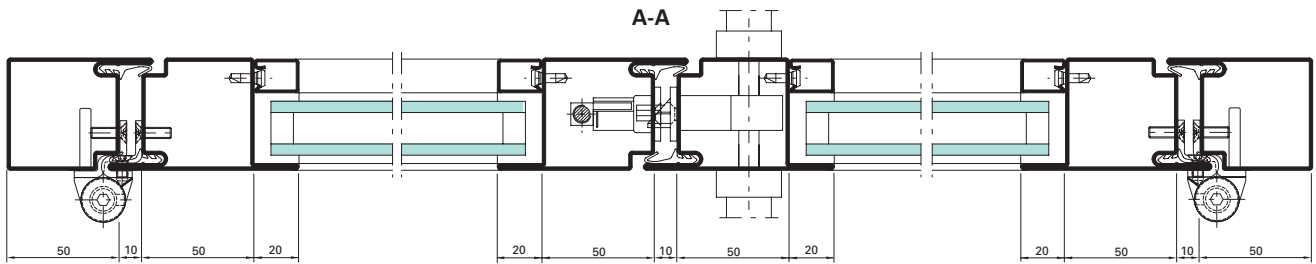

Jansen-Economy 50 pencere örnekleri

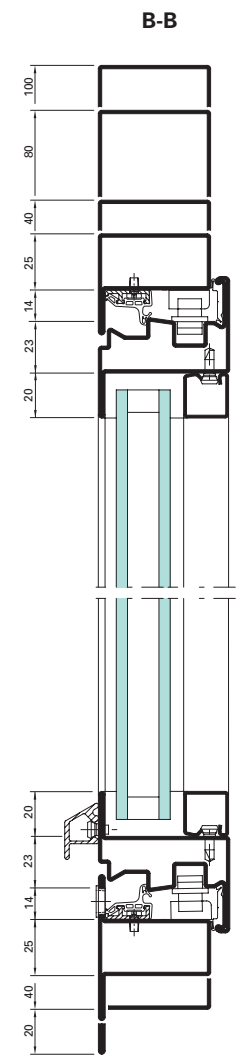
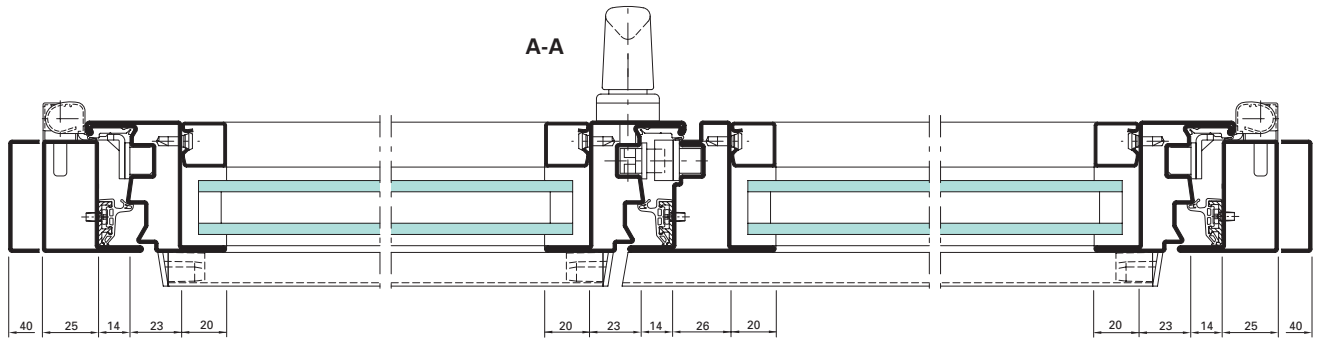

Gizli pencere aksamı

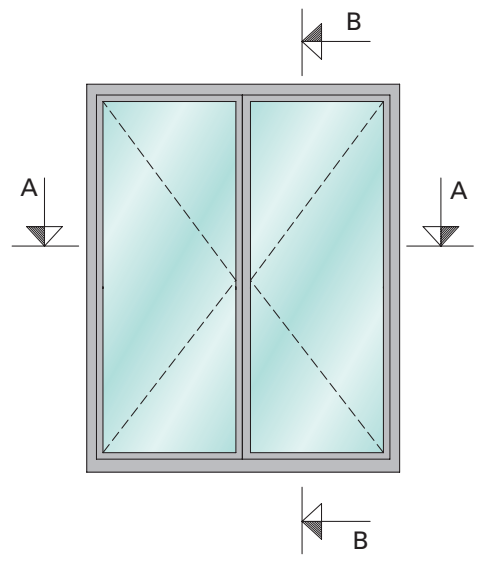
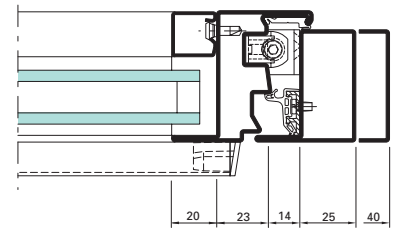



Chanel Boutique «Crystal Houses», Amsterdam/Hollanda  
(Jansen-Economy 50 paslanmaz çelik)



# Jansen-Economy 50 Paslanmaz çelik



## Tüm gereksinimler için mükemmel seçim

Jansen-Economy 50 paslanmaz çelik profilleri iki farklı ürün kalitesinde artık mevcuttur. 1.4404 (AISI 316L) ve 1.4307 (AISI 304L) modern çelikleri, çelik alanındaki en son teknoloji ile şekillenmiştir. Mimari ve fonksiyonel gereksinimlere göre normal ve agresif atmosfer şartlarına özel uyarlanmıştır. Gereksinimlere özel kullanım, malzeme

maliyetlerinin belirgin optimizasyonuna imkân vermektedir. Profil tasarımları ve profil derinlikleri Jansen-Economy çelik profilleri ile özdeşdir. Bu sayede tasarımcı, profil serilerini, imalatçı da aynı aksesuarları kombine edebilmektedir. Pek çok paslanmaz çelik bağlantı elemanı, pencere ve kapı ürün gamını tamamlamak üzere sisteme eklenmiştir.

**Tuz ve klor konsantrasyonu içermeyen, agresif olmayan atmosfer koşullarında 1.4307 (AISI 304L) malzemesi tercih edilir:**

- Kırsal bölge
- Konut ve endüstriyel alanlar
- İç mekan alanları

**Tuz ve klor içeren ortamlarda 1.4404 (AISI 316L) malzemesi dirençlidir.**

**Bu nedenle:**

- Endüstriyel alanlar
- Kıyı bölgeleri
- Hijyen gerektiren alanlar
- Yola yakın bölgeler (tuz yükü olan)



## Jansen-Economy 50 paslanmaz çelik kapı örnekleri

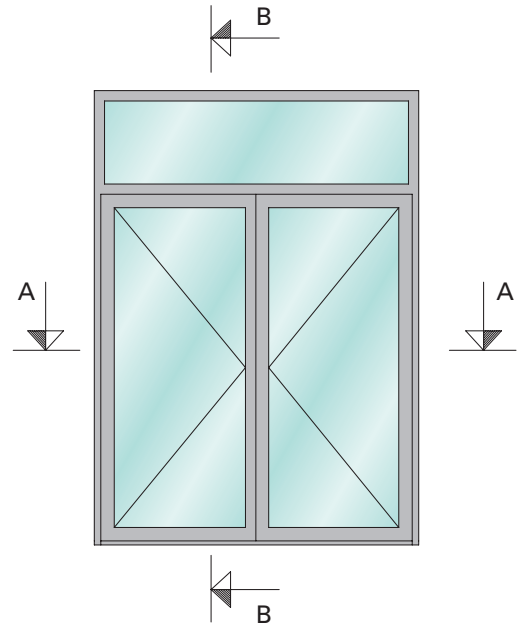
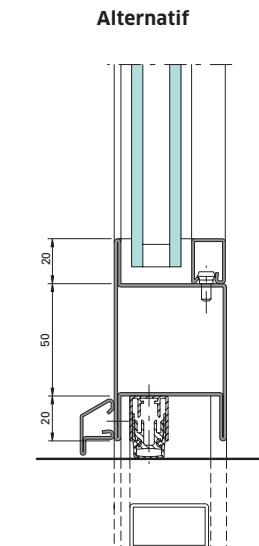
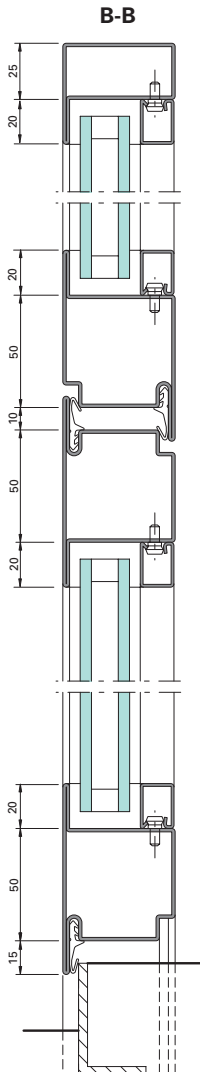
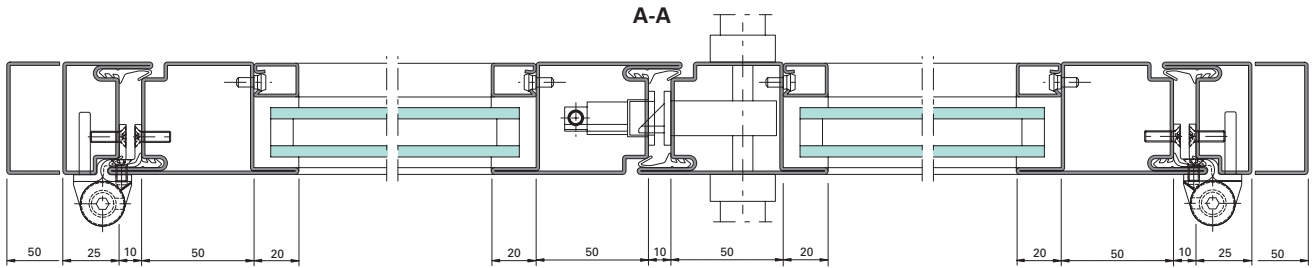

Jansen-Economy 50 paslanmaz çelik pencere örnekleri

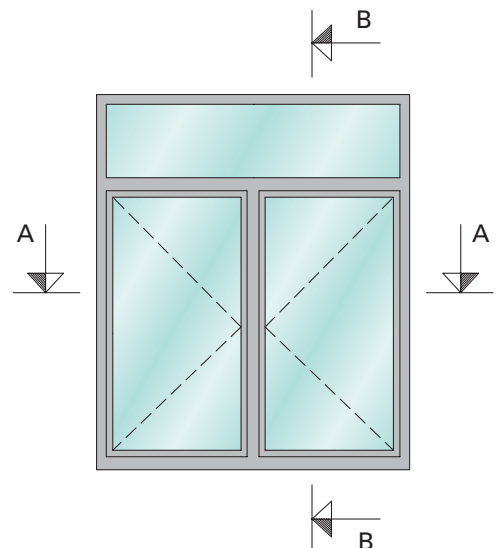
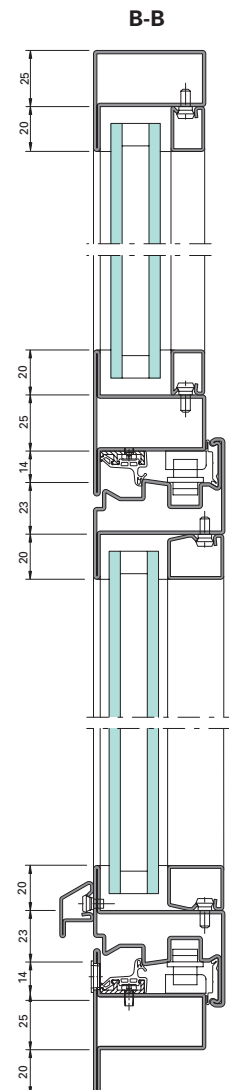
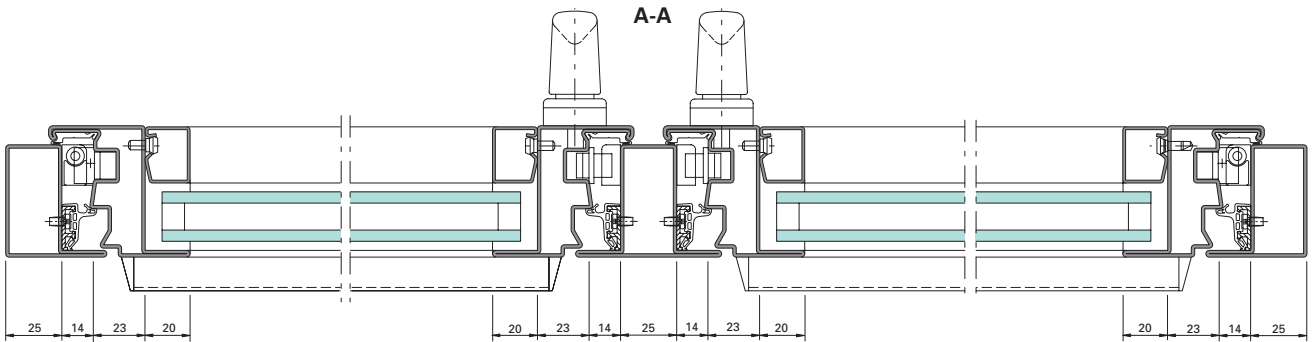

# Profil Gami

## Jansen-Economy 50

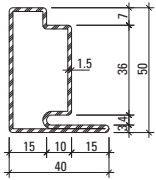

30.006  
30.006 Z  
30.006.01  
30.006.05

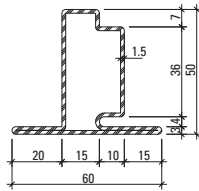

30.106  
30.106 Z  
30.106.01  
30.106.05

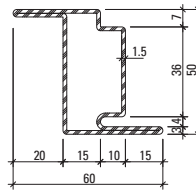

30.406  
30.406 Z  
30.406.01  
30.406.05

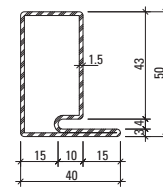

30.021

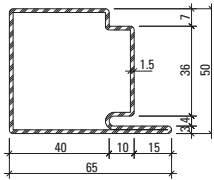

30.007  
30.007 Z  
30.007.01  
30.007.05

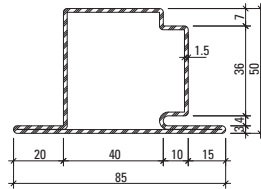

30.107  
30.107 Z  
30.107.01  
30.107.05

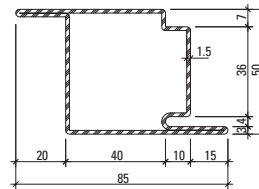

30.407  
30.407 Z  
30.407.01  
30.407.05

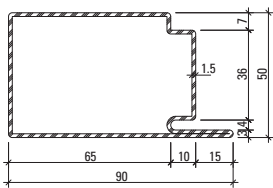

30.008  
30.008 Z

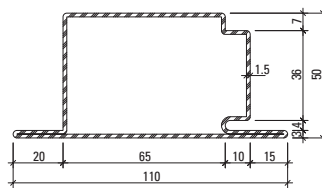

30.108  
30.108 Z

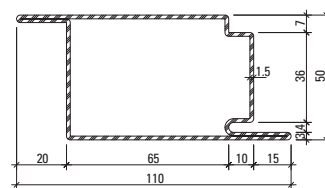

30.408  
30.408 Z

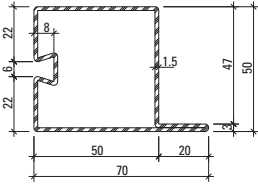

32.388  
32.388 Z

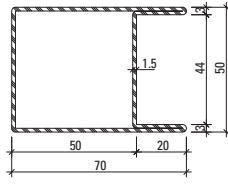

04.568  
04.568 Z

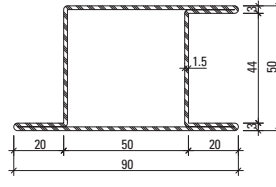

05.568  
05.568 Z  
05.568.01  
05.568.05

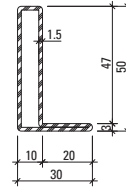

01.531  
01.531 Z

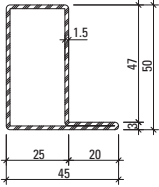

01.534  
01.534 Z  
01.534.01  
01.534.05

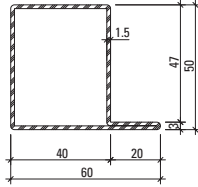

01.564  
01.564 Z  
01.564.01  
01.564.05

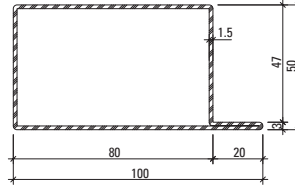

01.592  
01.592 Z

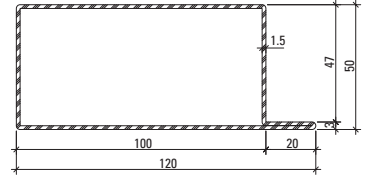

01.596  
01.596 Z

Z= galvanizli çelik

01 = Paslanmaz çelik, parlak,  
Malzeme 1.4404 (AISI 316L)

05 = Paslanmaz çelik, parlak,  
Malzeme 1.4307 (AISI 304L)

Paslanmaz çelik profiller taşlanmış  
yüzey olarak imal yapılabilir. Yüzey  
görünümleri 220-240 veya 320-400  
grit büyüklüğünde zımparalanmış  
sipariş edilebilir.

# Profil Gami

## Jansen-Economy 50

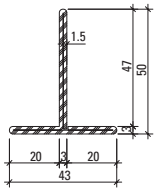

400.023  
400.023 Z

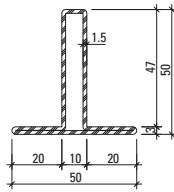

02.531  
02.531 Z

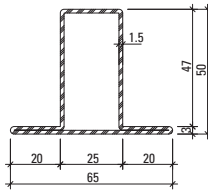

02.534  
02.534 Z  
02.534.01  
02.534.05

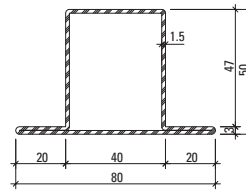

02.564  
02.564 Z  
02.564.01  
02.564.05

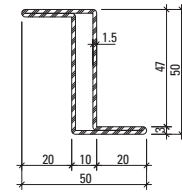

03.531  
03.531 Z

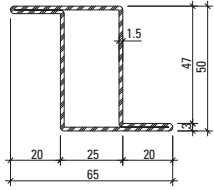

03.534  
03.534 Z  
03.534.01  
03.534.05

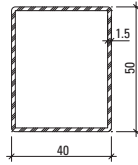

400.048  
400.048 Z

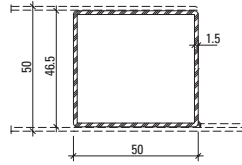

400.049  
400.049 Z

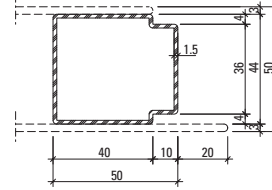

81.009 Z

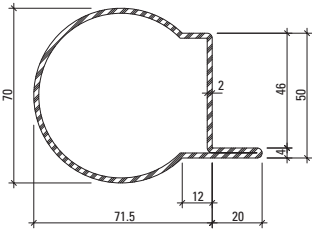

60.153  
60.153 Z

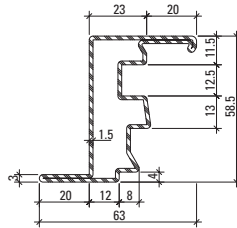

30.900  
30.900 Z  
30.900.01  
30.900.05

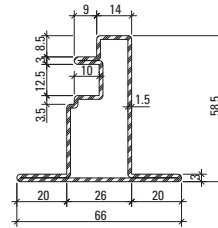

30.901

Z= galvanizli çelik

01 = Paslanmaz çelik, parlak,  
Malzeme 1.4404 (AISI 316L)

05 = Paslanmaz çelik, parlak,  
Malzeme 1.4307 (AISI 304L)

Paslanmaz çelik profiller taşlanmış yüzey olarak imal yapılabilir. Yüzey görünümleri 220-240 veya 320-400 grit büyüklüğünde zımparalanmış sipariş edilebilir.



# Profil Gami

## Jansen-Economy 60

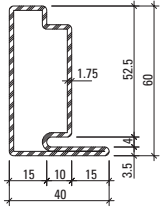

30.018  
30.018 Z

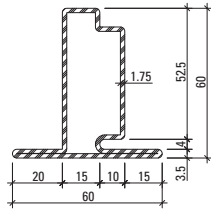

30.118  
30.118 Z

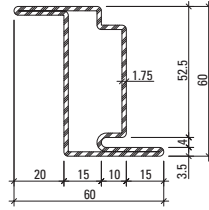

30.418  
30.418 Z

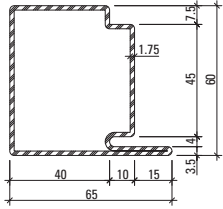

30.019  
30.019 Z

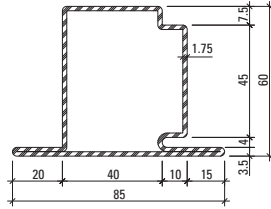

30.119  
30.119 Z

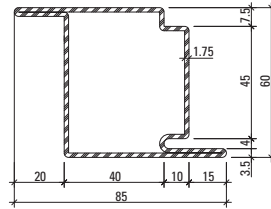

30.419  
30.419 Z

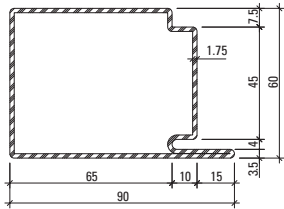

30.017  
30.017 Z

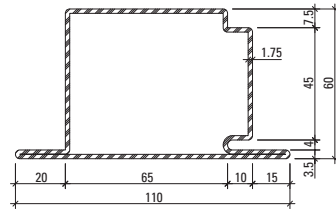

30.117  
30.117 Z

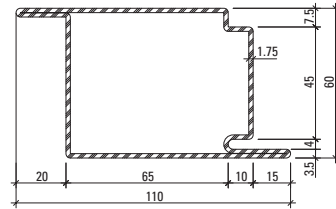

30.415  
30.415 Z



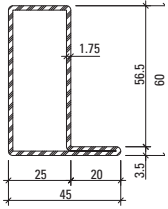

01.634  
01.634 Z

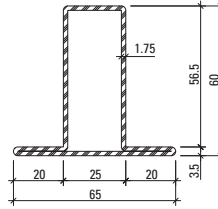

02.634  
02.634 Z

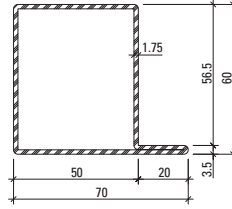

01.684  
01.684 Z

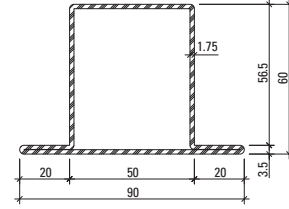

02.684  
02.684 Z

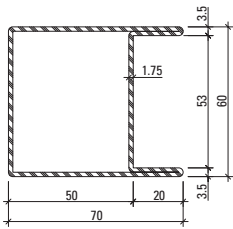

04.637  
04.637 Z

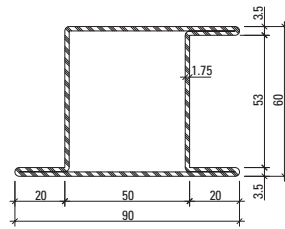

05.637  
05.637 Z

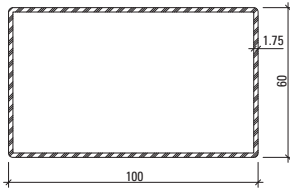

400.051  
400.051 Z

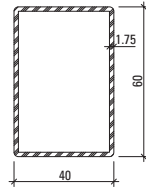

400.052  
400.052 Z

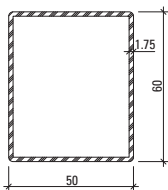

400.054  
400.054 Z

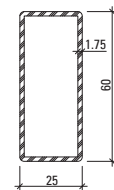

400.055  
400.055 Z

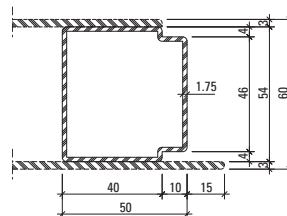

81.010 Z

Z= galvanizli çelik

# Jansen-Economy 60 Katlanır kapı



## Çelik katlanır kapı

Bu katlanır kapı, yalıtımsız Jansen-Economy 60 sistemini temel almaktadır. Kullanım esnekliği sayesinde katlanır kapı sistemi iç mekân bölücü olarak kullanıldığı gibi dışarıda da kullanılır. İç ve dışa açılabilir. Uyumlu bağlantı elemanı ve aksesuarları düzenli, sessiz ve uygun çalışmayı garanti eder.

Eşik için farklı tasarımlar mevcuttur. Ölçü ve kanat ağırlığına bağlı olarak 25 mm ve 50 mm ön görünüm yüzey genişliğine sahip profiller kullanılabilir. Üst hareket mekanizmasının yük taşıma kapasitesi 200 kg olup, bu da 100 kg kanat ağırlıklarına izin vermektedir.



Jansen-Economy 60 katlanır kapı örneği

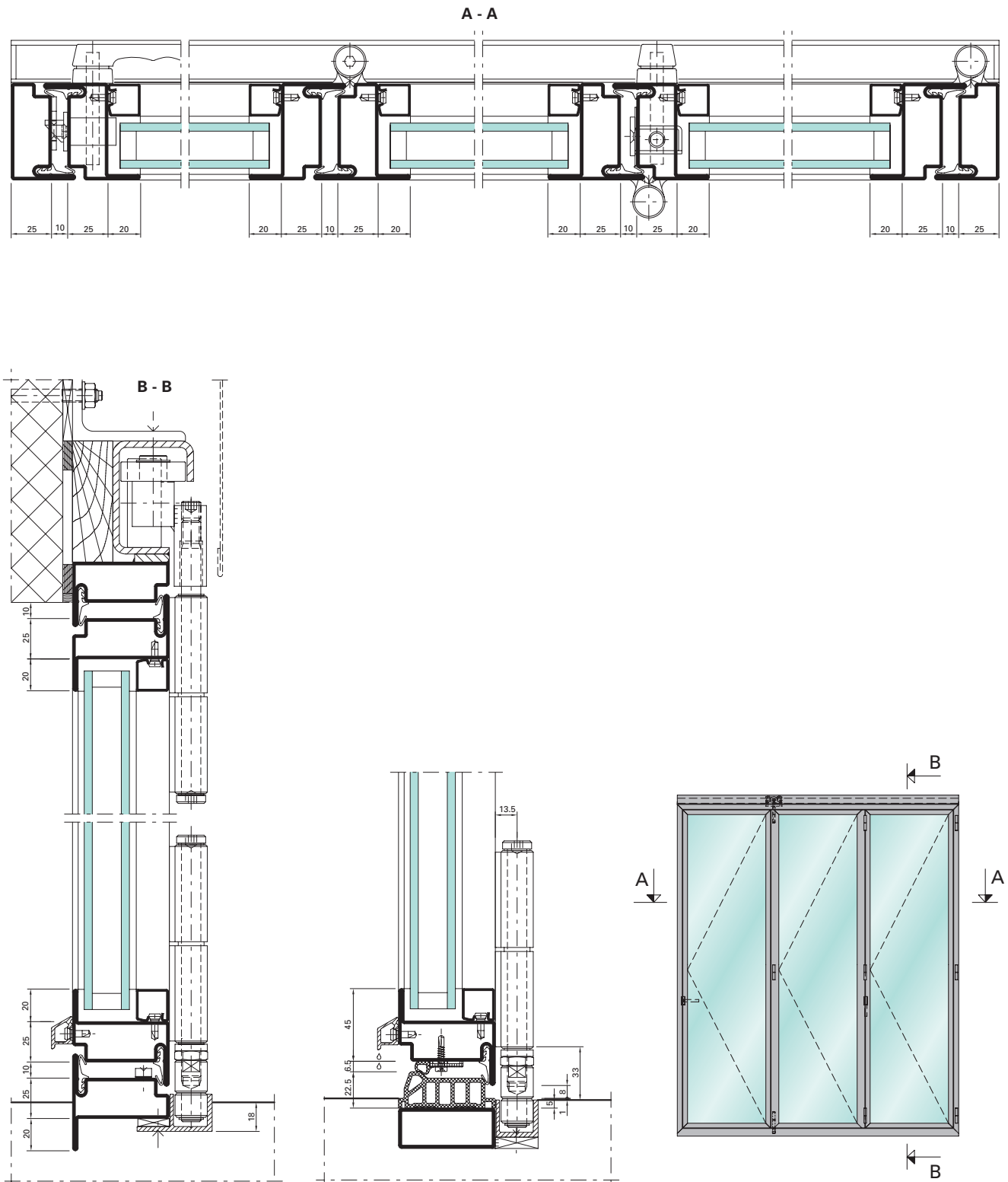

# Katlanır ve kayar kapılar

## Manuel ve otomatik



Jansen, katlanır ve kayar kapılar için, tüm gereksinimleri karşılamak üzere 50 mm, 60 mm, 80 mm profil derinliğine sahip, aksesuar ve bağlantıları temin eder. Katlanır kapılarda farklı eşik uygulamaları bulunmaktadır. İçe veya dışa açılır olarak ve istenen kanat adedine göre tasarlanabilir. Kullanım alanlarında yerden tasarruf sağlar. Mimari tasarımlar doğrultusunda

belirlenmiş olan dolgu paneller veya cam dolgu uygulamalarında kullanılabilir. Profil ve conta gamı hem manuel, hem de otomatik kumanda edilen kapı sistemleri için uygundur. Tamamlayıcı bağlantı elemanlarının tümü test edilmiş, güvenilir, sessiz ve düzgün işleyişle uzun bir servis ömrünü garanti eder.

Jansen kayar kapıları, Gilgen'in hareket mekanizmaları ile birlikte, EN 13241-1 ile test edilmektedir. Bu sayede çözüm ortaklarımıza, hem manuel hem de otomatik kapıların CE markalaması için gerekli tüm ön koşulları sağlamaktayız.

### Profile Gamı

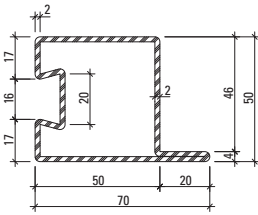

32.373

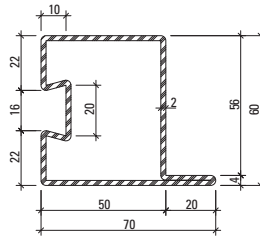

32.374

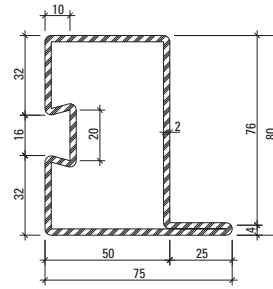

32.382

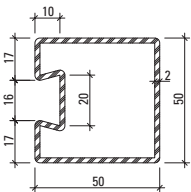

76.731

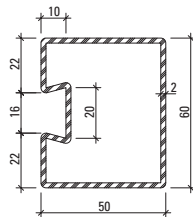

76.732

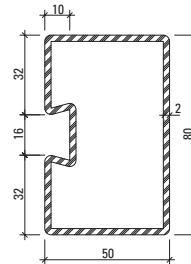

76.733

Katlanır kapı örnekleri

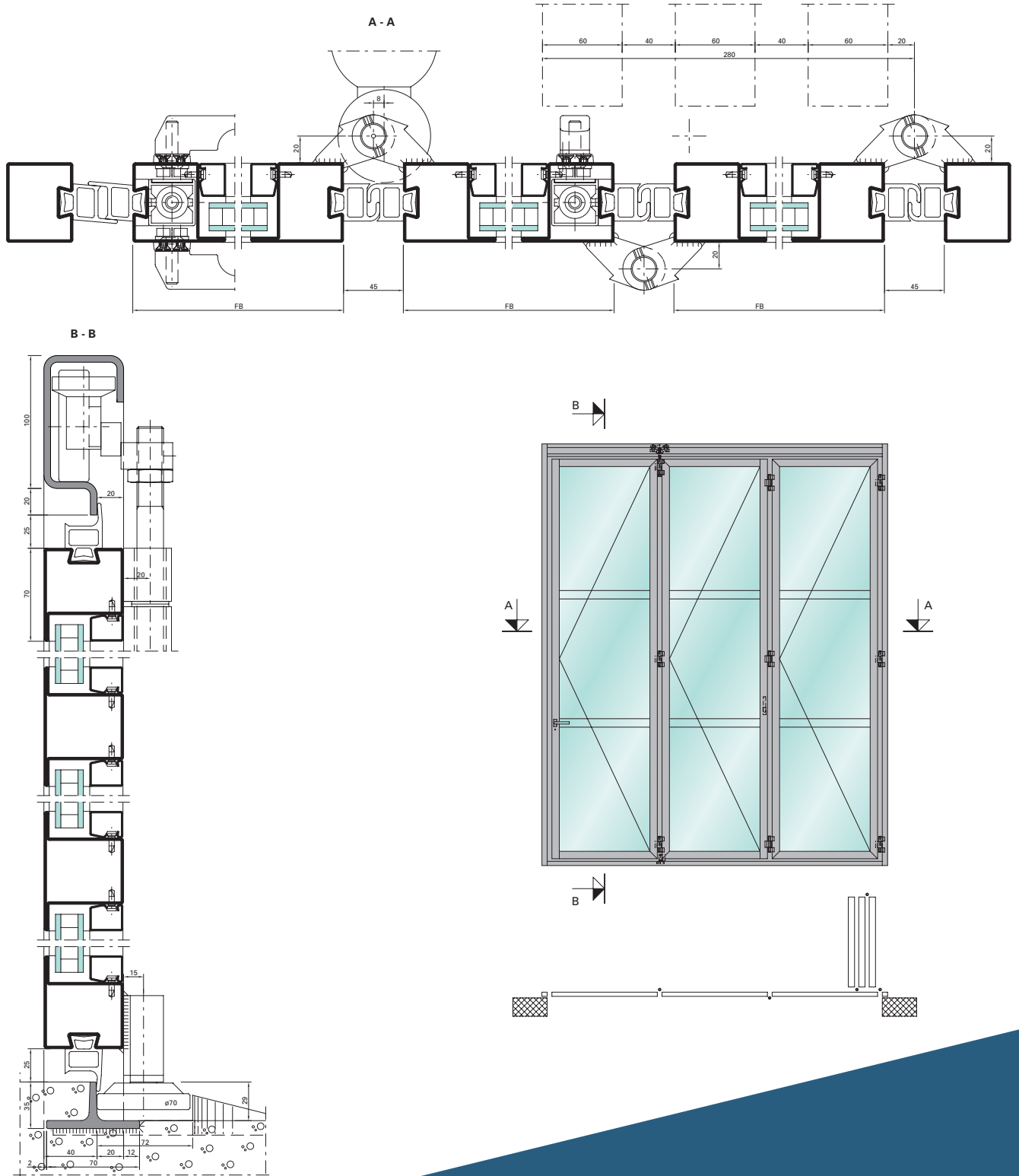

# Jansen Art'System Pencereleler

## Yalıtımsız pencere ve pencere/kapılar için ince çelik profil sistemleri

Jansen Art'System yalıtımsız bir pencere ve pencere/kapı sistemidir. Öncelerinde Fransa pazarı için geliştirilmiş olup, sonrasında Jansen tarafından EN 14351-1 ile uyumlu bir sistem haline getirilip sertifikalandırılmıştır. Jansen Art'System, tarihi binaların renovasyonu için özel olarak tasarlanmıştır ve binaların dış görünümünde yüksek beklentiler gerektiren tescilli binalar için özel olarak geliştirilmiştir. Jansen Art'System, içe açılır pencerelerin ve "pencere kapı"ların mevcut eski hali ile uyumlu bir şekilde imalatına olanak verirken aynı zamanda yenilikçi ve ekstra inceliğiyle yeni binalarda da alan kullanımından kazandırması ile belirleyici bir rol oynar. Jansen Art'System'in ince görünümü, günümüz mimarlarının geniş cam alanlarını ince kesitlerle gerçekleştirmelerine de olanak tanımaktadır.



Profil gami

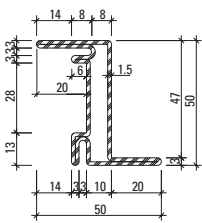

30.614 Z

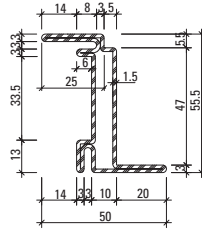

30.613 Z

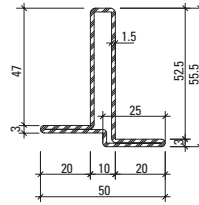

12.550 Z

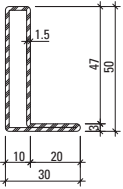

01.531  
01.531 Z

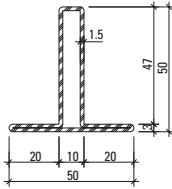

02.531  
02.531 Z

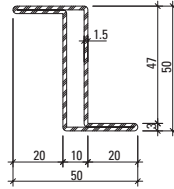

03.531  
03.531 Z

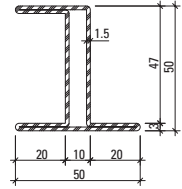

05.531 Z

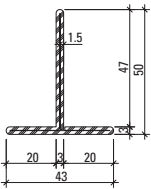

400.023  
400.023 Z

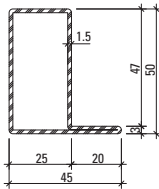

01.534  
01.534 Z

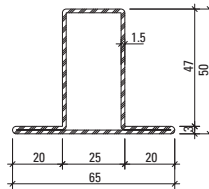

02.534  
02.534 Z

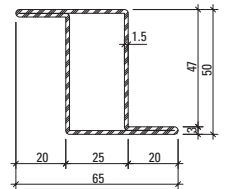

03.534  
03.534 Z

Z = galvaniz çelik

Jansen Art'System örnekleri

D - D

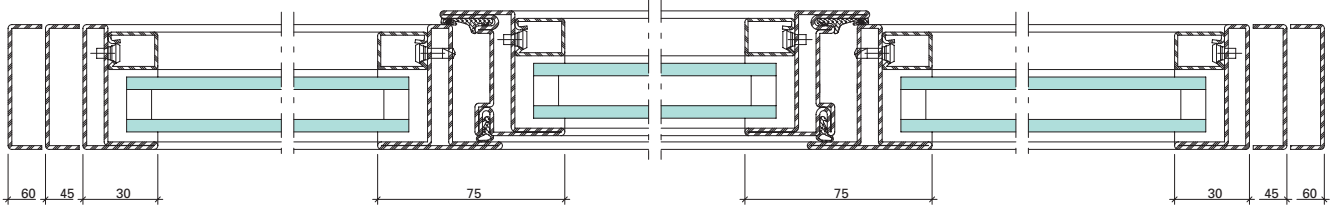

E - E

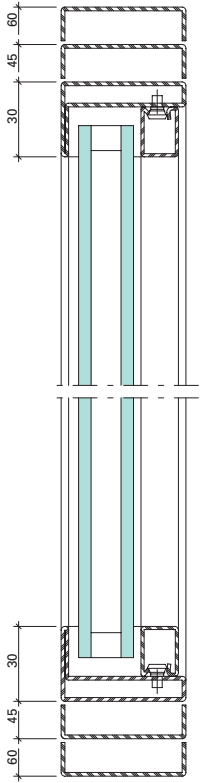

F - F

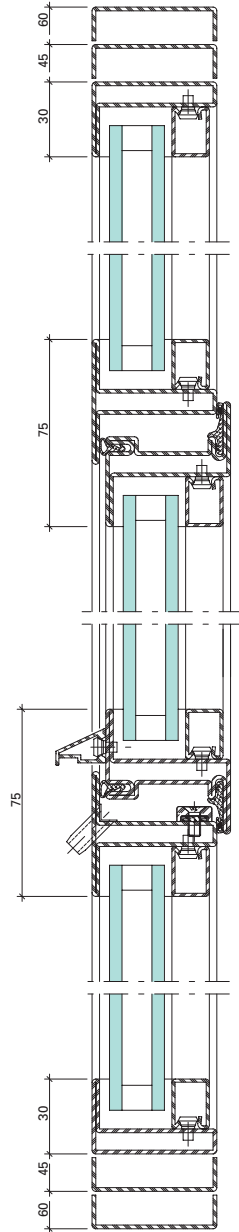

Alternatif

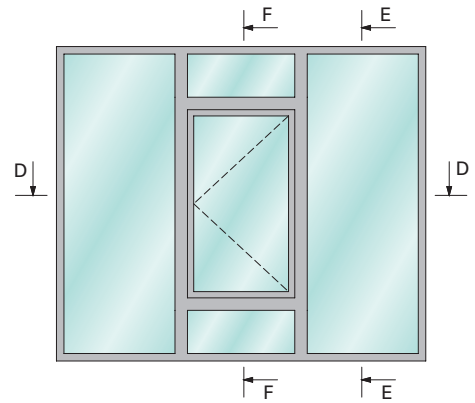
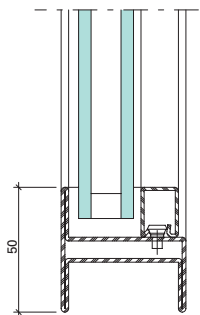



Jansen Art'System örnekleri

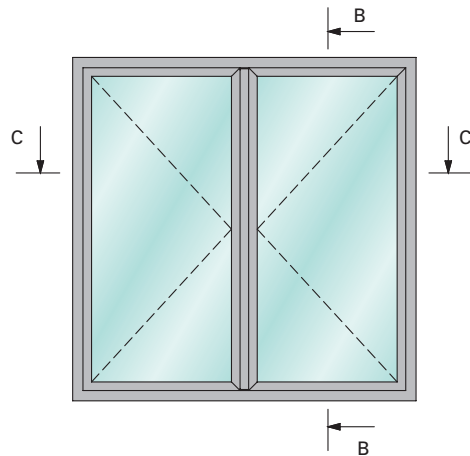
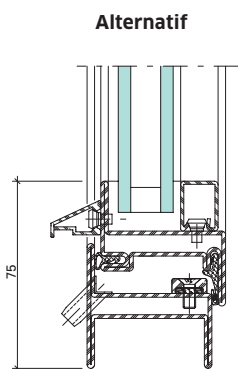
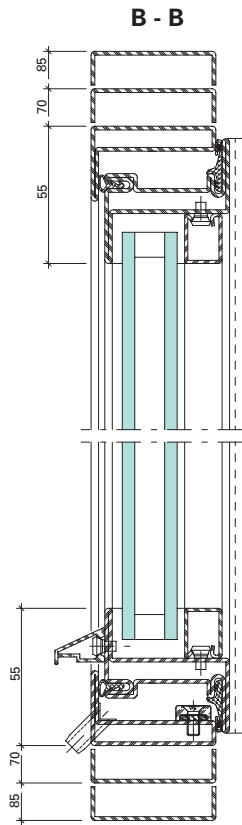
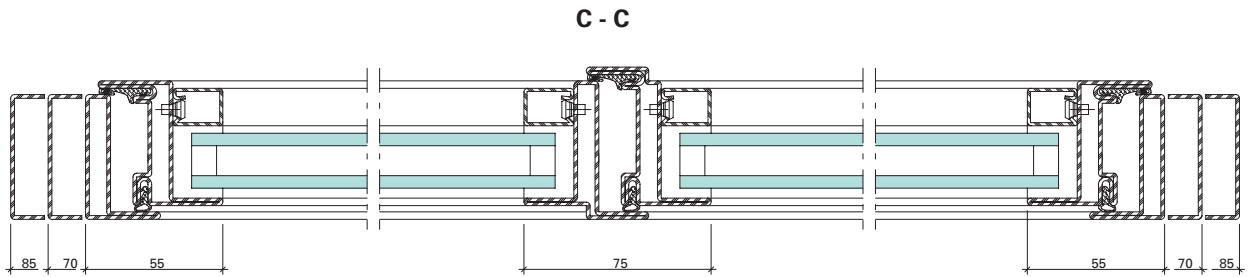

# Jansen Art'15 Kapılar ve sabit camlamalar

## İç mekan kapılar ve sabit camlamalar için ince çelik profil sistemi

Jansen'in yeni yalıtımsız çelik profil sistemi olan Jansen Art'15'in son derece azaltılmış yüzey genişliği benzersiz bir tasarıma izin verirken, kullandığı çelik malzeme ile uzun ömürlü kullanım sağlar. Bu şekilde, Jansen Art'15, sadece iddialı mimarların yüksek tasarım taleplerini değil aynı zamanda bilinçli son kullanıcıların işlev açısından yüksek bek-

lentilerini de karşılar. Jansen Art'15 kapı ve cam bölmeleri maksimum şeffaflık ile giriş salonunu oturma odasından, mutfağı yemek odasından veya ev-ofis alanını oturma odasından ayırır. Olabilecek en ince formda çelik profil sistemi, her zaman benzersiz, ince bir çerçevede dayanıklı, oldukça sağlam yapılar sağlar.



Profil gamı

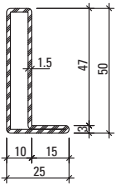

01.115

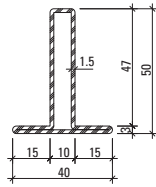

02.115

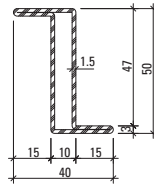

03.115

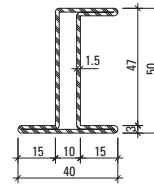

05.115

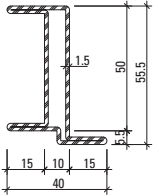

05.116

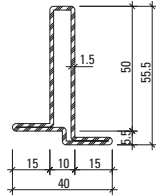

02.116

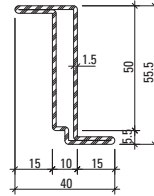

03.116

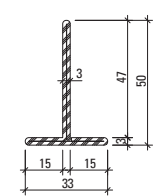

400.020

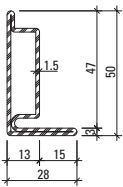

30.005

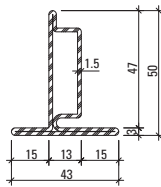

30.105

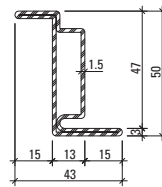

30.405

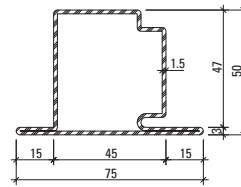

30.109

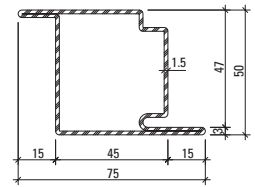

30.409

## Profil gamı Jansen Art'15

**Binili profil görünümü**

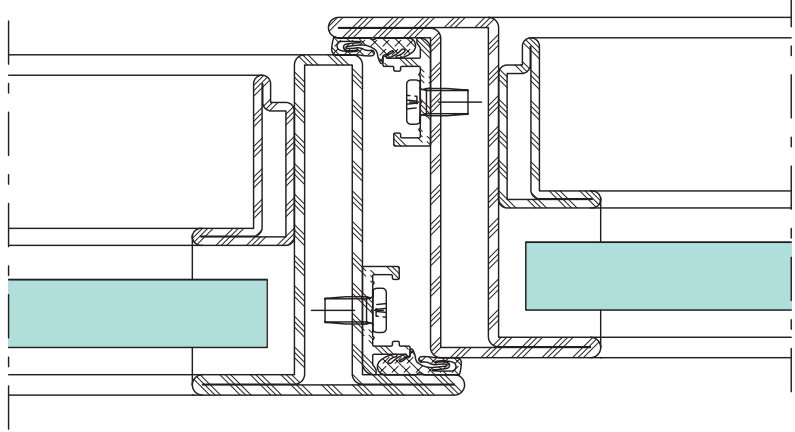

**Kanlı profil görünümü**

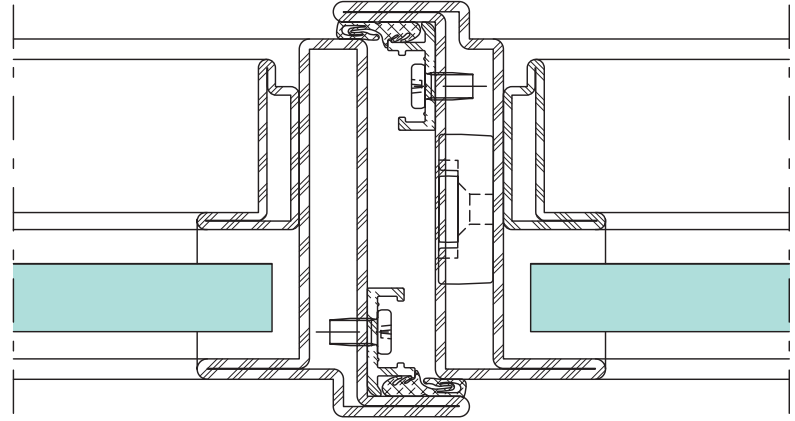

**Hemyüz profil görünümü**

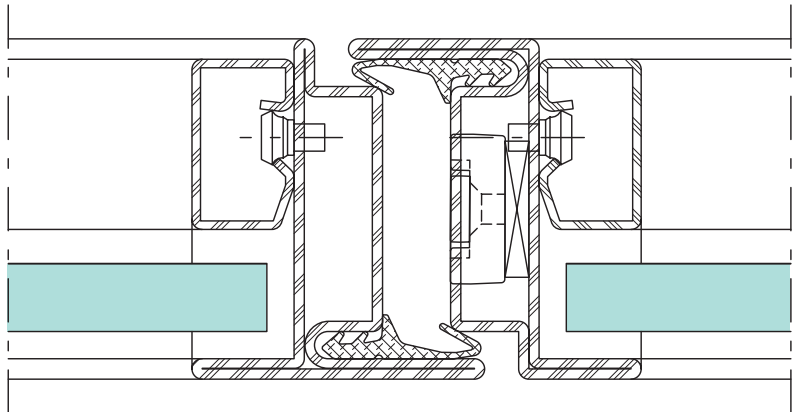

Jansen Art'15'te alternatif camlama seçenekleri

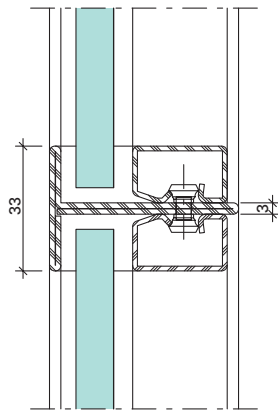
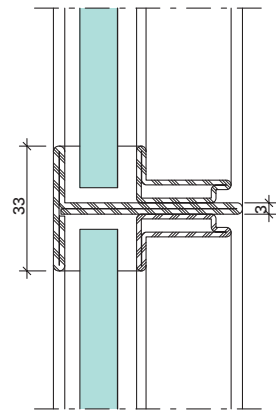
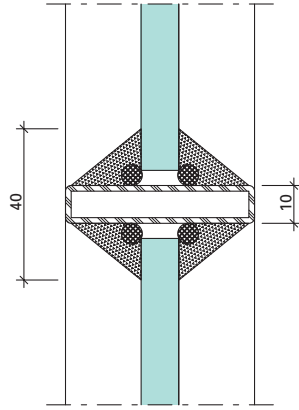
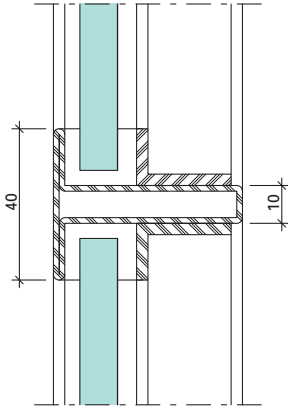
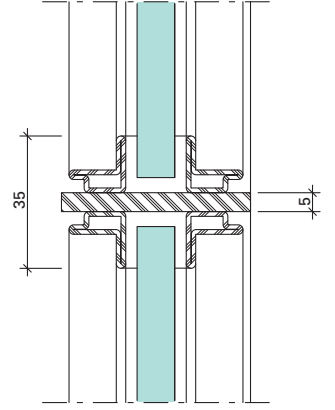
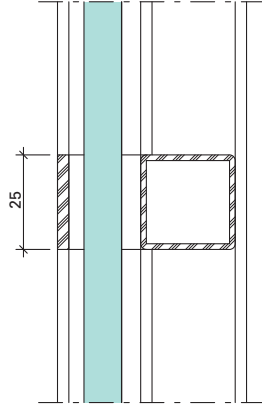
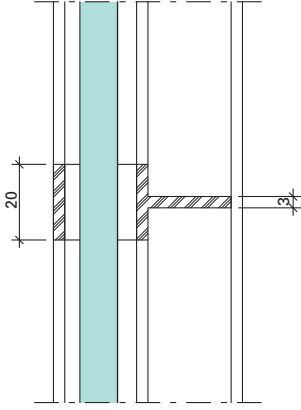



# Standart Profiller

## Kapı ve Pencereleler

40, 50, 60 ve 80 mm profil derinliğine sahip kapsamlı bir profil gamı, kapı ve pencereler için tasarım seçeneklerini sunmaktadır. Yan kesitler ve üst pencerelere sahip fonksiyonel ve cazip tek ve çift kanat tasarımları yanısıra eğimli kapı ve çarpma kapı tasarımları da bulunmaktadır. Sabit doğrama ile çeliğin mükemmel yapısal özellikleri açıkça görülebilir. İnce kasa ebatlarına imkân verdiği gibi burulma dirençli birimler ve hatta daha geniş açıklık içeren yapılara da imkân vermektedir.

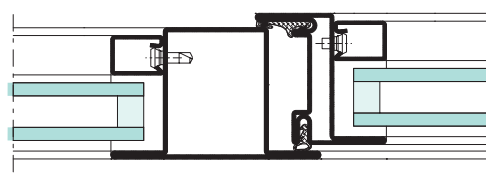

Standart pencere profilleri

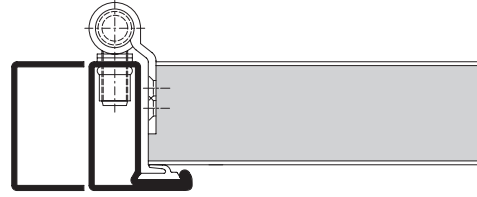

Çerçeve kapılar

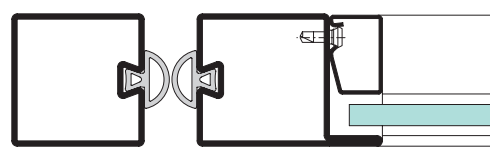

Çarpma Kapılar

# Profil Gami

## Standart profil 50 mm

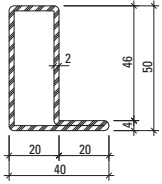

01.535

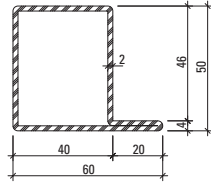

01.565

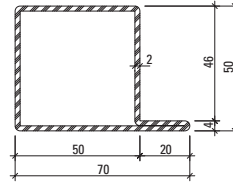

01.570

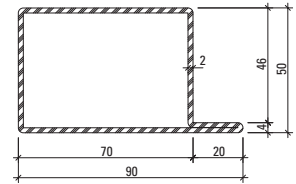

01.590

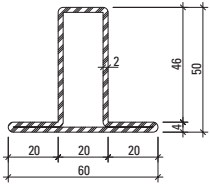

02.535

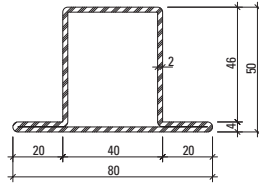

02.565

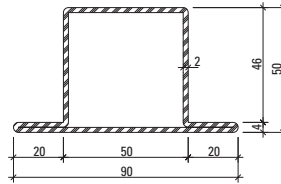

02.570

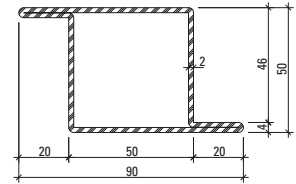

03.570

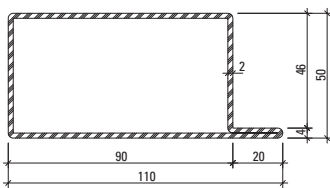

01.587

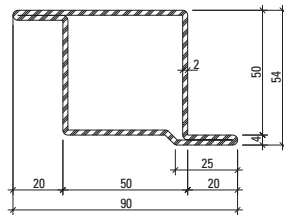

13.570

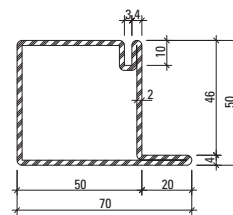

30.030

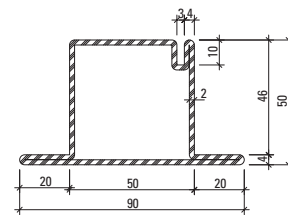

30.235



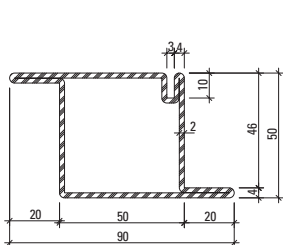

30.265

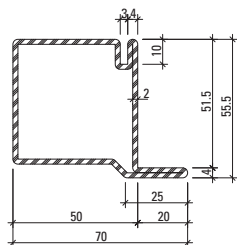

30.430

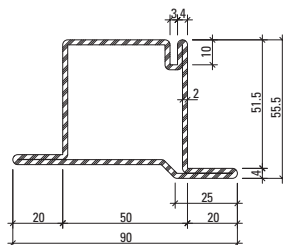

30.628

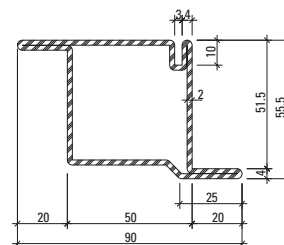

30.465

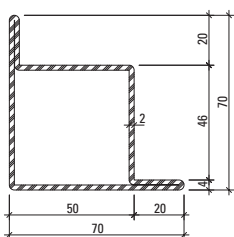

06.570

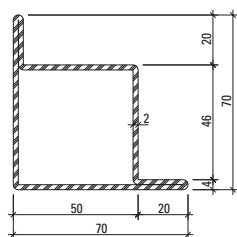

07.570

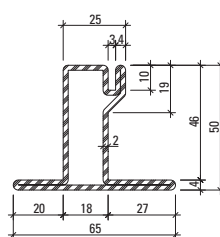

30.600

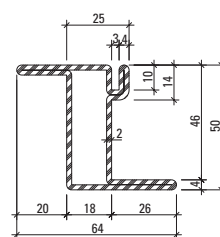

30.620

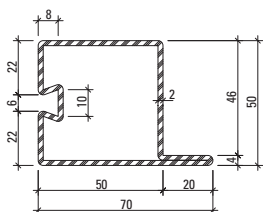

32.366

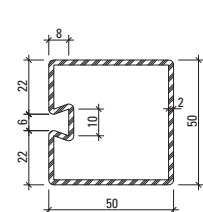

76.726

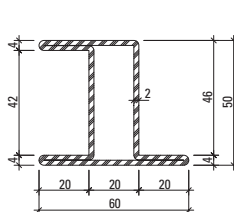

05.535

**Kasa profili**

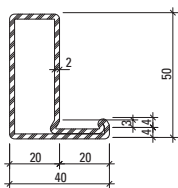

32.109

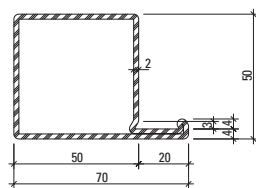

32.042

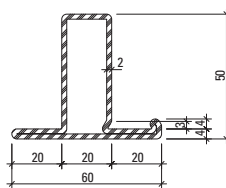

32.085

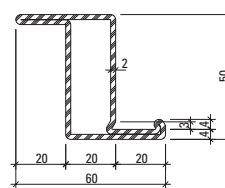

32.105

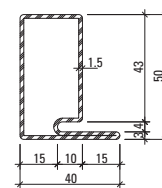

30.021

Kapı ve pencere örnekleri

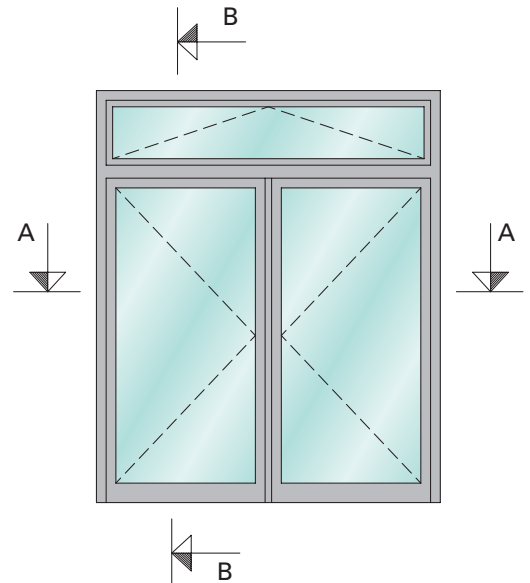
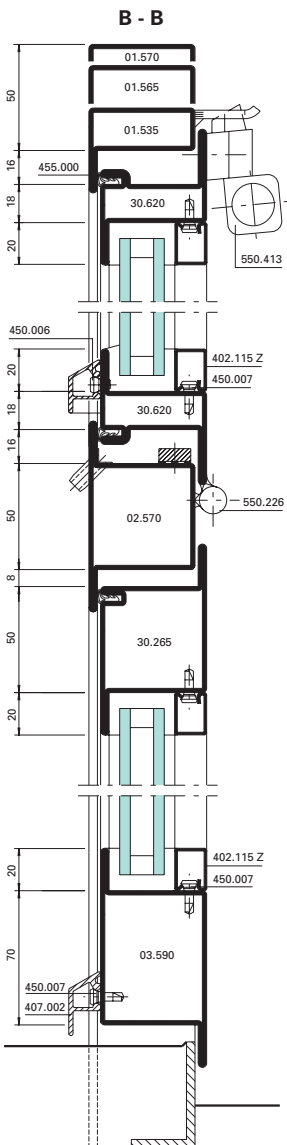
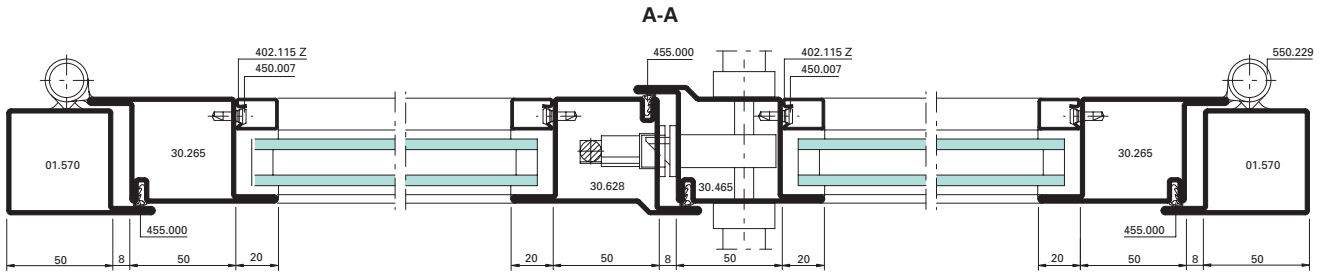

Çerçeve kapı ve pilastr profil örnekleri

Alternatif

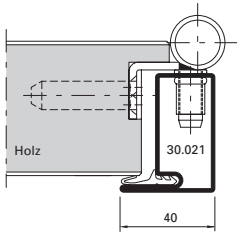

Alternatif

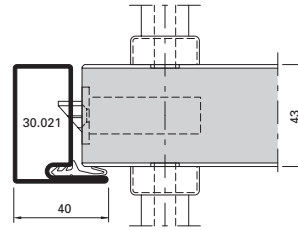
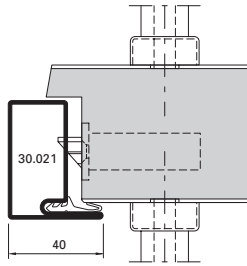

A - A

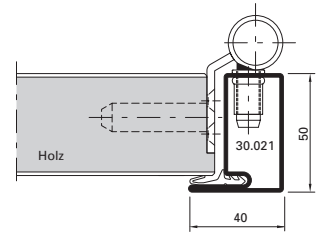

Alternatif

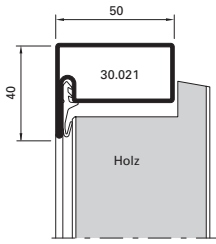

B - B

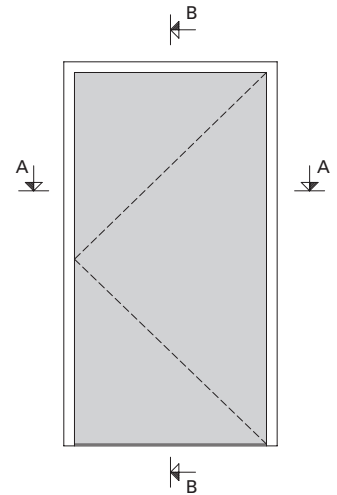
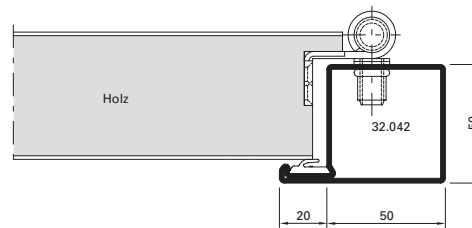
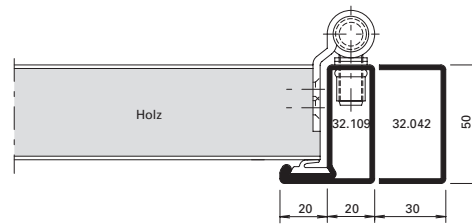
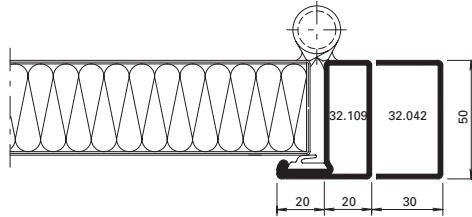
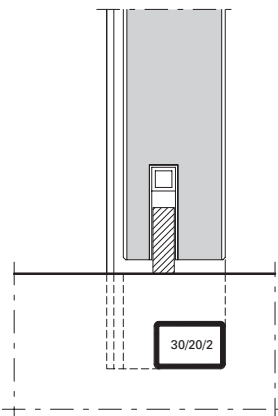
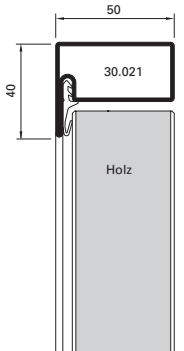





# Cam ıtaları

## elik ve alüminyum

### Sıcak daldırma galvaniz elik cam ıtaları (uzunluk 6 m)

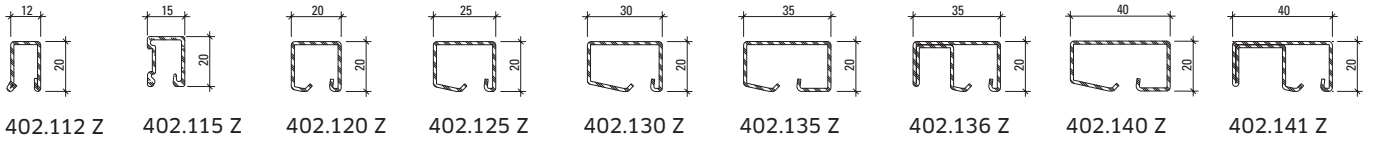

### Paslanmaz elik cam ıtaları (uzunluk 6 m)

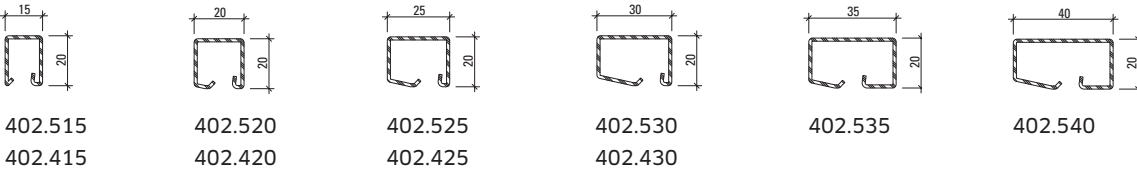

### Alüminyum cam ıtaları (uzunluk 6 m)

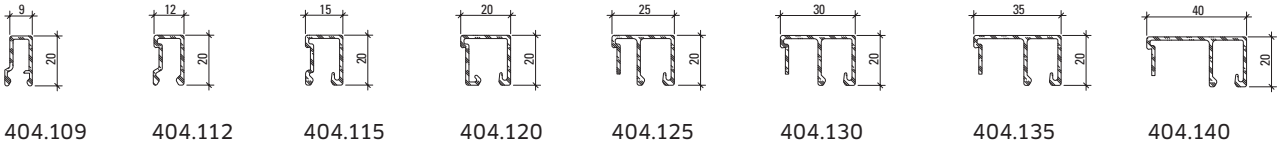

### Aılı kontürlü elik cam ıtaları (uzunluk 6 m)

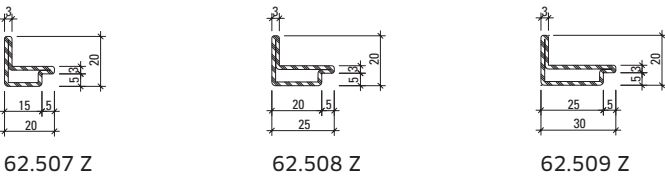

### Alüminyum cam ıtaları (uzunluk 6 m)

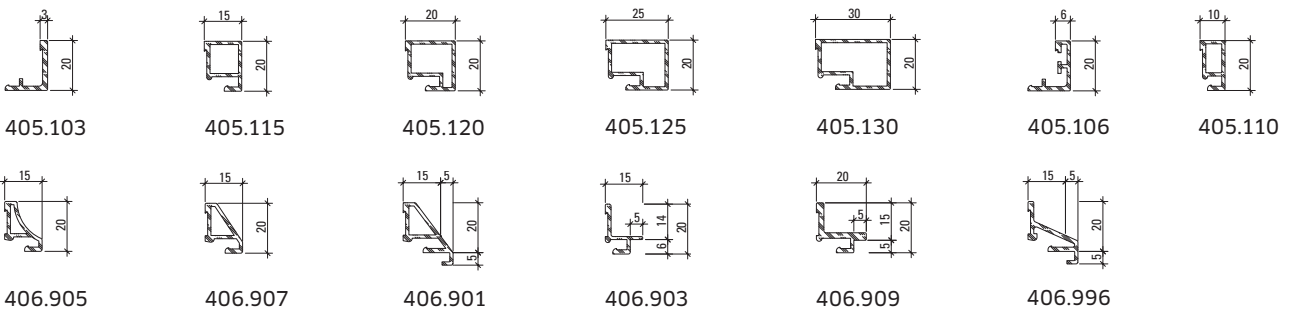

# Sistem çok yönlülüğü: her uygulama için



**Duman ve yangın kapıları ve camlamaları**



**Mulyon ve transom konstrüksiyonları için yalıtımlı çelik sistemleri**

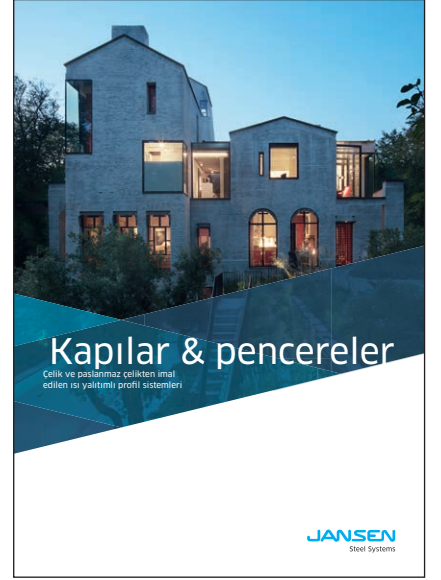

**Çelik ve paslanmaz çelik yalıtımlı profil sistemleri**



**Çelik ve paslanmaz çelik profil sistemleri ile bireysellik**

**Daha fazla broşür ve dökümanı  
jansen.com adresindeki Download  
Merkez'inde bulabilirsiniz.**

Jansen AG

**Türkiye İrtibat Bürosu**  
Süleyman Seba Cad. No:48  
BJK Plaza Blok A Kat 3, D:38  
34357 Beşiktaş / İstanbul  
Phone +90 212 259 69 12  
Fax +90 212 259 69 13  
info.turkey@jansen.com

**JANSEN**